

Massage Chair

Product Name : JP-1100

Category: machinery and appliances
 general designation: household
 electric massage chair

User manual

Attached document

Refer to 10~17 pages how to assemble each parts on the massage chair.



Before use

- IMPORTANT SAFETY INSTRUCTIONS 3
- Names and Functions 8
- Setup and assembling 10
- Before starting massage every time 18

How to use

Auto Mode

- Adjust the reclining and footrest angle 20
- Massage by Auto Mode Course 22
 - Auto Mode Course starts
 - Adjustment during auto course method
- About the end of Massage 28

Manual Mode

- Rubbing massage 30
 - Start the desired rubbing massage
 - How to adjust during massaging
- Air massage 35
 - Start air massage
 - How to adjust during massaging
- Parts intensive massage 38
- Combine the rubbing and air massage 40
- Foot roller massage 41
- When changing the Massage in the middle 42
- Memory course usage 44
- Heater ON/OFF 47
- QUICK MODE/LANGUAGE/AUTO-RECLINE settings . 48
- To set the child lock 50

Maintenance/Q&A

- Maintenance and storage 52
- Q&A 54

Customer service

- Trouble shooting 56
 - Checkpoints
- Specifications 58



Purpose of use, effect-efficacy

Substitution of massage for home-use



- Thank you very much for purchasing Fujiiryoki massage chair.
- Carefully read this operation manual before use and only use as directed.
- Please read the safety precautions on pages 3-7 before use.
- Keep this operation manual where it will be readily available for future referral.
- Please recycle the outer packaging material where possible.

IMPORTANT SAFETY INSTRUCTIONS

- Read these "Important Safety Instructions" before use and use this product properly
- These important safety instructions are prescribed to ensure correct usage of the product, and to prevent injury and damage to the user and other persons.
- Followings are the display and contents.
- Please keep to the regulations as these are important instructions for your safety.

 DANGER	Improper usage may result in serious injury or death.
 WARNING	Improper usage may result in injury or damage to property.*

*Property refers to houses, household belongings, domestic animals and pets.

	<p>⊘ Prohibited actions The prohibited action is illustrated inside the illustration (for example, the illustration on the left refers to "Prohibiting disassembling")</p>
	<p>● Directives, actions which are compulsory The prohibited action is illustrated inside the illustration (for example, the illustration on the left refers to "unplugging the power plug")</p>

- Always keep this operation manual where it will be readily available for referral.
- Attention: When disposing of this product and/or its accessories, do so in accordance with local laws and regulations. For details, please refer to your local authority.

DANGER

	<p>TheBecause this equipment has a built-in heater and the surface becomes hot, person who are not sensitive to heat should pay attention to use. Pay full attention when it falls under the following.</p> <ul style="list-style-type: none"> ●elderly, ailing person, those who cannot operate by themselves ●persons who took medicine that cause drowsiness(sleeping pills, cold medicine) ●persons with heavy drinking, heavy tiredness ●persons with hematogenous disorder (diabetes, etc.) ●persons who recieve a note from the doctor ●people with weak temperature sense. <p>There is a risk of low temperature burns, dehydration.</p> <p>The following persons must consult a medical physician before using this product.</p> <ul style="list-style-type: none"> ●Persons using a medical electronic device embedded in the body such as a pacemaker susceptible to the electromagnetic disturbances. ●persons with malignant tumors. ●persons with heart diseases. ●persons who are pregnancy or those immediately after childbirth. ●persons who suffer from paresthesia related to peripheral circulatory disturbance due to diabetes etc. ●persons with wounds on their skin. ●persons in need of repose. ●persons with Temperature sensory loss. ●persons with body temperatures exceeding 38°C. (when strong acute inflammation symptoms, malaise, hills, blood pressure fluctuations are observed, when debilitated) ●persons with herniated discs. ●a person with tendovaginitis. ●persons who suffer from osteoporosis, spinal column fractures, or acute pains. ●persons with abnormalities in the spine, or those whose spines are bent. ●persons who feel an abnormality on the body not prescribed above, persons in treatment by a doctor.
---	--

IMPORTANT SAFETY INSTRUCTIONS



DANGER

	<p>If the chair stops moving or any abnormalities occur, unplug the power plug and contact the point of purchase for an inspection/repairs. Electrification, short circuits and fire may occur.</p>
	<p>Take care of the movements of the knead balls when massaging around neck. Avoid excessive massaging or massaging the front of the neck. Accidents or injuries may occur.</p>
	<p>When reclining or lowering the footrest, always check underneath and surroundings the footrest for people, pets, and other items. Accidents or injuries may occur.</p>
	<p>When reclining or lowering the footrest, be careful not to get hands, fingers, feet, head caught underneath the footrest or backrest. <ul style="list-style-type: none"> ●underneath the chair itself ●backrest, seat, clearance of armrest ●clearance of footrest, seat, armrest ●underneath the footrest, the back of footrest ●clearance between arm and armrest ●behind the backrest Accidents or injuries may occur.</p>
	<p>Before use, check underneath the back pad to make sure that there are no rips or tears in the cover cloth of the seat back. (should there be any rips or tears, no matter how small, immediately discontinue use, disconnect the power cord, and ask for repairs to be conducted). Continued use with rips or tears in the cloth of the seat back may cause electric shocks or injuries.</p>
	<p>Always unplug this appliance from the electrical outlet immediately after using and before cleaning.</p>
	<p>Not long term use of heater and same spot on the body If heat is used on the same spot for a long time, low temperature burns may occur even if the temperature is comparatively low in 40-60°C.</p> <div style="border: 1px solid black; padding: 5px; margin-top: 10px;"> <p>About low temperature burn —————</p> <ul style="list-style-type: none"> ●low temperature burn effect the deep part of the skin and show red specks or blisters. ●In case red specks or blisters are found, consult a medical physician immediately. </div>
	<p>The following persons are strongly recommended not to use this product. Certain prohibited from receiving a massage by a medical physician. (for example those suffering from thrombosis, severe aneurysm, acute varicose veins, various kinds of dermatitis and skin infections (including inflammations of subcutaneous tissue), etc.)</p>
	<p>Do not remove, rip or cut the cover of the chair(backrest, footrest, armrest) on purpose. Never use the chair with the cover removed or torn as clothes and hair may get caught in the knead balls.</p>
	<p>Do not use the chair other than on the designated voltage. Fire or electrification may occur.</p>
	<p>Do not use the chair when the power cord or its plug is damaged, or when the receptacle is loose. Contact your point of purchase for repairs if the power cord or power plug are damaged in anyway. Continued usage may result in electric shocks, shortage, or even fire.</p>
	<p>Surely plug the power plug to the root and keep away from the dust. Doing so may cause damage, fire and electrification.</p>
	<p>Do not allow unattended children or persons unable to declare their own intentions to use this chair. Do not allow infants near the chair. Electrification or injuries may occur.</p>
	<p>Do not allow children to play or get on the chair. Accidents or injuries may occur.</p>
<p>Do not connect or disconnect the power plug with wet hands. Electrification may occur.</p>	



DANGER



Do not use or store in the bathrooms or places of high humidity or moisture. Electrification, fire, accidents, and moulding may occur.



Never remodel or decompose/repair by yourself. Fire or injury due to abnormal action may occur.



WARNING



Usage of this product should be limited to 30 minutes for each use. Continual use on the same part of the body should be limited to 5 minutes. Prolonged use may damage muscles and nerves. (Only use for 30 minutes per day.)

The following persons should consult a medical physician before using this product.
● persons whose muscles have become weak due to increasing age, and those who are of slim build. ● persons suffering from lower back pain caused by bones or internal organs.
● persons easily bruised, susceptible to sprains. ● persons who suffer from intense motion sickness. ● persons who have undergone internal organ or heart operations.

If any rashes, reddening of the skin, itches or similar symptoms appear after using this product, immediately stop using and consult a physician. Accident and ill health may occur.

An appliance should never be left unattended when plugged in. Unplug from outlet when not in use, and before putting on or taking off parts. To disconnect, turn all controls to the off position, then remove plug from outlet. This may result in accidents due to children's mischief.

Use the chair on a level surface. Do not use outdoors. Damage or accidents may occur.

Make sure operation buttons and timers are operating normally before use. Accidents or injury may occur.

Read the operation manual once again and confirm the product is operating normally before using the chair after a prolonged period of non-use. Accidents or injury may occur.

Confirm no items get caught in the chair (backrest, footrest, armrest) before use. Never drop or insert any object into any opening. Accidents or injury may occur.

Do not place feet or hands on the footrest when the footrest is retracting. Accidents or injury may occur.

When any physical abnormalities appear or are felt during operation, stop using the product immediately and consult a physician.

Sit down slowly after confirming the knead balls are located at the storage position. Accidents or injury may occur.



Use weak stimulation massage when you start to use. Injury may occur.



Make sure the ground terminal is installed. Damages or electrification may occur when ground terminal is not installed.

IMPORTANT SAFETY INSTRUCTIONS

WARNING

	Turn the power switch OFF and unplug the power cord immediately in times of power shortages. When power is restored accidents may occur.
	Unplug the power plug by holding the actual power plug and not the cord. This may cause electrification, short circuits, or fire.
	Unplug the power plug when not using the chair. This may cause a fire due to insulation degradation by dust or humidity.
	When maintaining the chair always unplug the power cord. This may cause electrification or injury.
	Do not damage the power cord or power plug. ●Do not hurt ●Do not damage ●Do not process ●unreasonably bend or pull. ●Do not twist ●Do not tie ●Do not place heavy items on the power cord. ●Do not get the power cord caught, especially when moving the chair. Never operate this appliance if it has a damaged cord or plug, if it is not working properly, if it has been dropped or damaged, or dropped into water. Return the appliance to a service center for examination and repair. Continued usage may result in electric shocks, shortage, or even fire.
	Do not use immediately after eating or consuming alcohol. Nausea, illness, accidents or injury may occur.
	Do not close to stoves or other sources of fire, nor smoke whilst using the chair. Do not use on heated carpets or other heating equipment. Do not operate under blanket or pillow. Excessive heating can occur and cause fire, Electric shock, or injury to persons. Keep the cord away from heated surfaces. This may cause fire.
	Do not stand on the seat, or get on the seat back, footrest, arm or shoulder portion of the chair. The user or chair may rollover and injury or accidents may result.
	Do not stand or sit down on upper part of the backrest, the front of the seat or on the footrest when the chair is reclining. The user or chair may rollover and injury or accidents may result.
	Do not try to sit or get up from the chair when the chair is reclining or the footrest is elevated. The user or chair may rollover and injury or accidents may result.
	Do not use accessories other than those which accompany the chair. Doing so may cause product malfunction.
	Do not use the hand/arm massage whilst wearing watches, rings, fake fingernail or bracelets. This may cause injury.
	Do not use the chair whilst wearing earrings, necklaces, scarves, or other ornaments. This may cause injury.
	Do not use the chair whilst wearing hard objects on the head, such as hair ornaments. This may cause injury.
	Do not use the thigh or hip massage with hard objects in pockets. This may cause accidents or injury.
	Do not use while naked. Direct massages on the naked body may damage the skin.
	Do not use on the elbow, knee, head, abdomen areas. Do not get hands or feet caught in the knead balls. Injuries may occur.
	Do not pull out the power cord, or turn off the power switch whilst using the chair. This may cause accidents or injury.



WARNING



Do not sleep whilst using the chair. This may cause ill health or injury.

Do not move the chair while people or items are on the chair. Damage or injuries may occur.

Make sure no more than 1 person is on the chair at any one time. Doing so may result in damage to the chair or injury.

Do not wipe with benzene, paint thinner or alcohol, nor spray with any pharmaceutical sprays. This may cause fire or electrification.

Not to be used for purposes other than massage purposes. This may cause damage or accidents.

Do not use other therapeutic equipments whilst using this product. This may cause ill health or accidents.

Do not haul the chair itself or move with the casters on the floor where it easily gets scratches.

Do not overturn the chair or subject the chair to any strong shocks. Damage or injury may occur.

Do not hit toes to the foot rollers. Injury may occur.

Do not operate where aerosol (spray) products are being used or where oxygen is being administered.

Use this appliance only for its intended use as described in this manual. Do not use attachments not recommended by the manufacturer.

Do not carry this appliance by supply cord or use cord as a handle.

Never operate the appliance with the air openings blocked. Keep the air openings free of lint, hair, and the like.

Close supervision is necessary when this appliance is used by, on, or near children, invalids, or disabled persons.

Never operate this appliance if it has a damaged cord or plug, if it is not working properly, if it has been dropped or damaged, or dropped into water. Return the appliance to a service center for examination and repair.

Keep the cord away from heated surfaces.

Use heated surfaces carefully. May cause serious burns. Do not use over insensitive skin areas or in the presence of poor circulation. The unattended use of heat by children or incapacitated persons may be dangerous.

Keep children away from extended foot support, back support (or other similar parts).

Connect this appliance to a properly grounded outlet only. See Grounding Instructions.

This appliance is not intended for use by persons (including children) with reduced physical, sensory or mental capabilities, or lack of experience and knowledge, unless they have been given supervision or instruction concerning use of the appliance by a person responsible for their safety.

Children should be supervised to ensure that they do not play with the appliance.

Cleaning and user maintenance shall not be made by children without supervision

Names and Functions

Chair

Front side

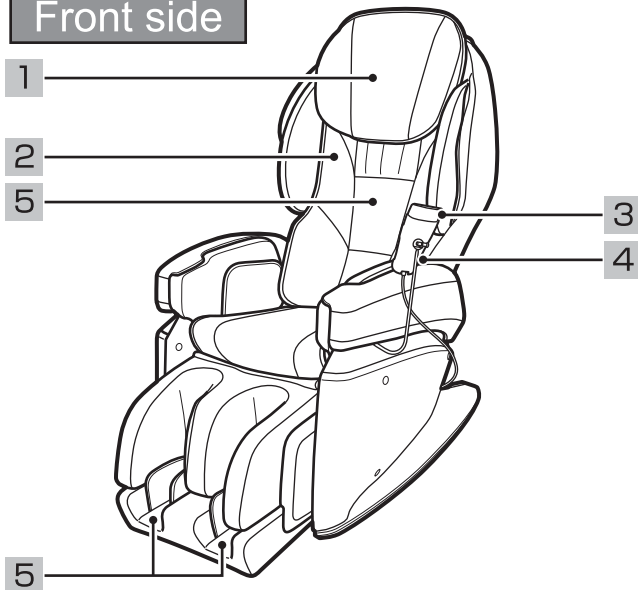

Rear side

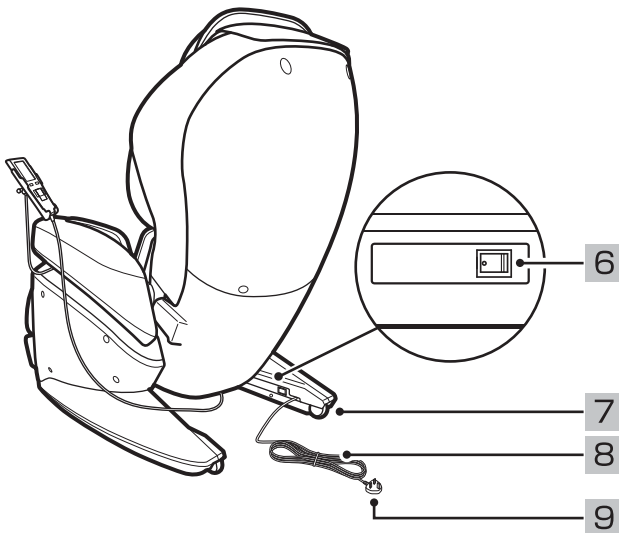

Massage position

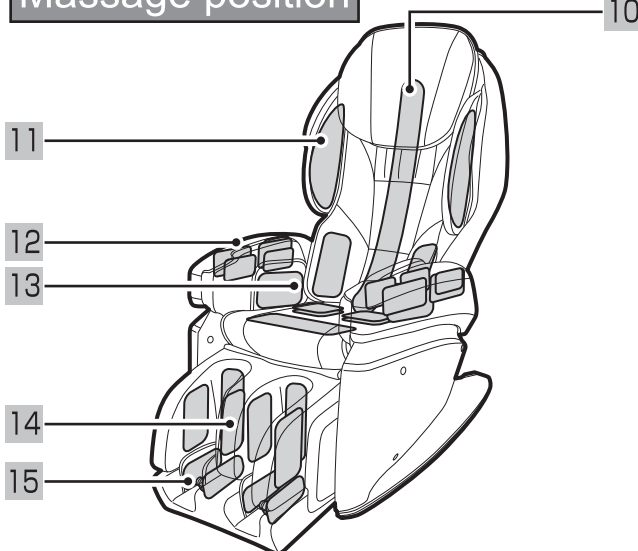

Front side

- 1 Pillow
Turn back the pillow pad during massage
- 2 Back pad
Slowly lean against the back pad
- 3 Remote control
- 4 Remote control stand
- 5 Heat
Built-in the back, sole of the feet

Rear side

- 6 Power switch
Turn the power switch OFF after use
- 7 Caster
- 8 Power cord
- 9 Power plug

Massage position

- 10 Backrest
Massage whole the back area of the body
- 11 Shoulder
Air massage for shoulder
- 12 Arm
Air massage for arm
- 13 Waist/Buttocks (Pelvis)
Air massage for waist, buttocks, around thigh
- 14 Footrest
Air massage for calf, feet
- 15 Foot roller
Roller massage for sole of the feet.

Remote control

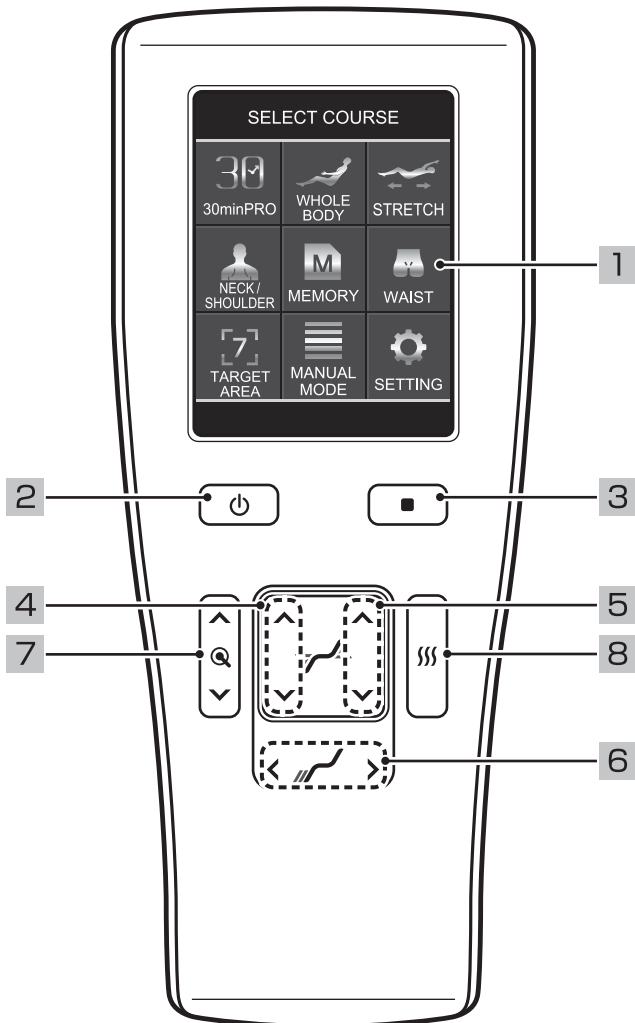

Front side

- | | |
|---|--|
| 1 | LCD screen (Touch panel) |
| 2 | ON/OFF button
on/off of the power supply |
| 3 | STOP button
Stop all operations.(Press this button to stop massages immediately.) |
| 4 | Footrest angle button |
| 5 | Reclining angle button |
| 6 | Footrest slide button |
| 7 | Knead ball position adjustment button |
| 8 | Heat ON/OFF button |

About operation method

LCD screen is a touch panel. The parts which can be operated through fingers are displayed in "gray" color and parts which cannot be operated are displayed in "Dark gray".

[Description of some Buttons]

- : Message gets stopped and returns to regular screen.
- : Returns to the previous screen.
The contents are not reflected when any option or setting is changed.
- : Options or setting are decided and reflected.

[Display side]

The parts which can be operated by pressing are displayed in "gray" color

The diagram shows the LCD screen in 'MANUAL MODE'. It displays 'BACK STRENGTH 12' with a progress bar and 'AIR STRENGTH' with '+' and '-' buttons. Below is a 'LOOP KNEAD UP' screen with a roller icon and 'Roller OFF' text. At the bottom, there are buttons for 'SELECT PROGRAM', 'ADVANCED OPTIONS', 'AIR', and 'CUSTOMIZE AIR MASSAGE'. A timer shows '16 min'. Three callout boxes explain the color coding: 'Parts which can be operated are displayed in "gray" color' (pointing to the back strength and air strength controls), 'Parts which cannot be operated are displayed in "Dark gray".' (pointing to the home and back buttons), and 'Parts which cannot be operated are displayed in "black" color' (pointing to the roller icon).

Setup and assembling

Check the Main unit and accessories

! WARNING

Do not use accessories other than those which accompany the chair. Doing so may cause product malfunction.

User manual documents	
● User manual	● Assembling leaflets

● Whole

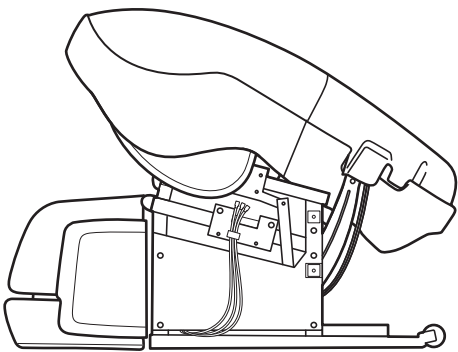

● Pillow

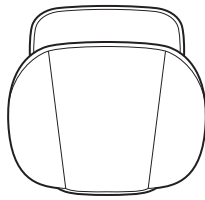

● Back pad

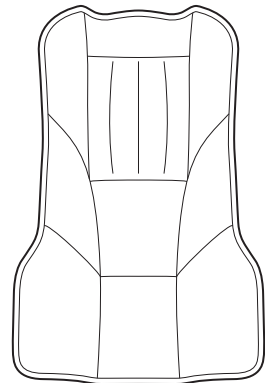

● Armrest (left)(right)

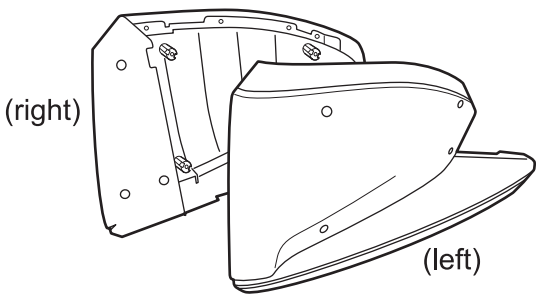

● Arm unit (left)(right)

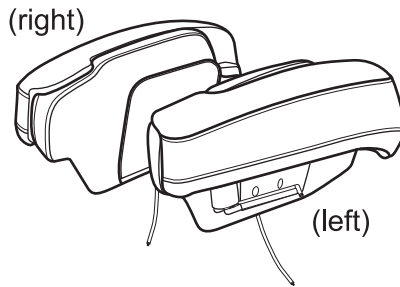

● Hex wrench

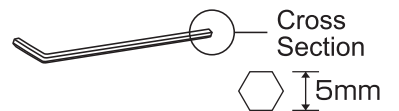

● Cap (8 No's)



※ There are symbols for each surface. Please check

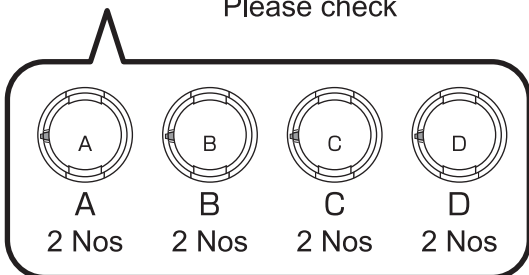

● Remote control stand

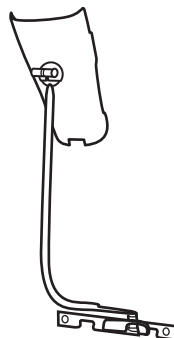

● Armrest fixing screw (short) 8 screws

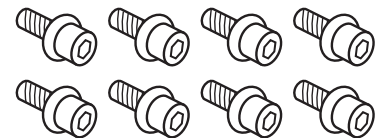

● Arm unit fixing screw (longer) 6 screws

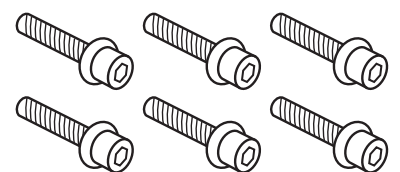

Deciding the setup place of whole unit

DANGER

Do not use or store in the bathrooms or places of high humidity or moisture. Electrification, fire, accidents, and moulding may occur.

WARNING

Use the chair on a level surface. Do not use outdoors. Damage or accidents may occur.

Do not close to stoves or other sources of fire, nor smoke whilst using the chair. Do not use on heated carpets or other heating equipment. Do not operate under blanket or pillow. Excessive heating can occur and cause fire, Electric shock, or injury to persons. Keep the cord away from heated surfaces. This may cause fire.

It should be installed in a flat surface where there is 50cm space from behind for reclining.

- If power supply is switched ON, then body automatically moves backwards and foot rest rises till it reaches the standby position. It is good to have the main unit surrounding with more than 35cm space from front and 50cm space from behind.
- During reclining, even the foot rest raises.
- Do not setup the whole unit in places where there is direct sunlight every day, or near heat appliances or near high temperature. Failure to do so may lead to color change or quality degrading in main unit.

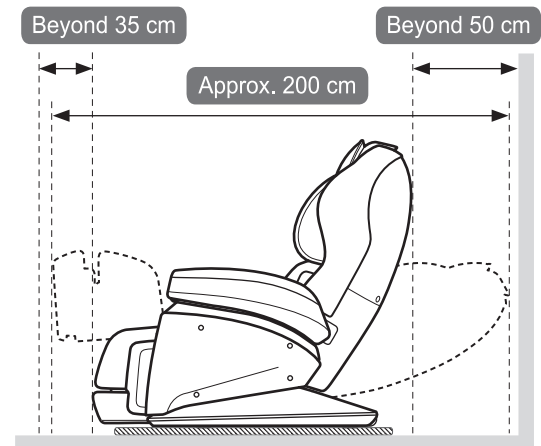

Whole Setup

WARNING

Do not move the chair while people or items are on the chair. Damage or injuries may occur.
Do not haul the chair itself or move with the casters on the floor where it easily gets scratches.
Do not pull the power chord or remote control chord with leg or wrap with caster.
Failure to do so may cause injury.

The front part and back part is lifted and operated using hands.

- Since it is a heavyweight unit, it should be carried by 2 or more persons.
- Watch your steps carefully and lower it slowly.

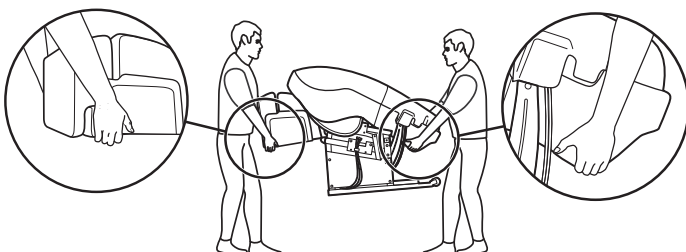

Frontage should be **70cm** or more (68cm width to carry the whole + 2cm width for protection)

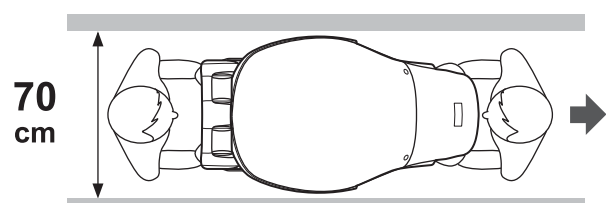

Raising the backrest part

Raise the backrest part in arrow mark direction and check that it is fixed in stopper (O part) position.
(Generates clinking noise)

- When moving the backrest part, hand or finger should not be inserted in between seat and back rest position.
- And care should be taken in such a way that remote control cord and power cord doesn't get held between seat and back rest position.

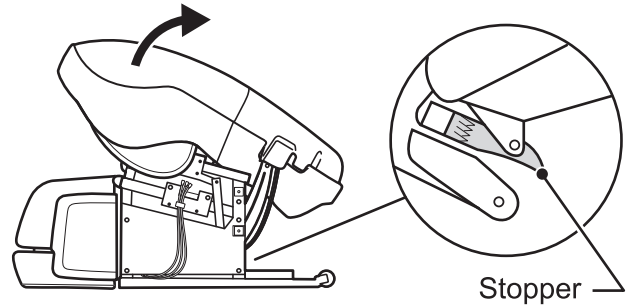

When lowering the backrest position

Press and raise the stopper from the center of backrest part as shown in arrow mark and lower forward the backrest part by hand support, after releasing the stopper.

- Care should be taken in such a way that it is not lowered suddenly.
- The backrest part should not be lowed when the arm rest and arm unit are not installed.
- During stopper operation, except the stopper lever, nothing should be touched.

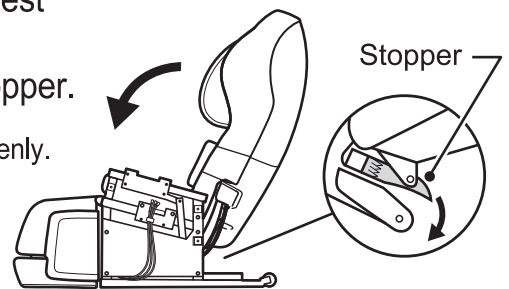

Arm unit installation (Both left and right direction)

1. Pass the yellow hose between the seat and the frame and install the arm unit. Match the convex part(①) of arm unit and recess part(②) of upper frame.

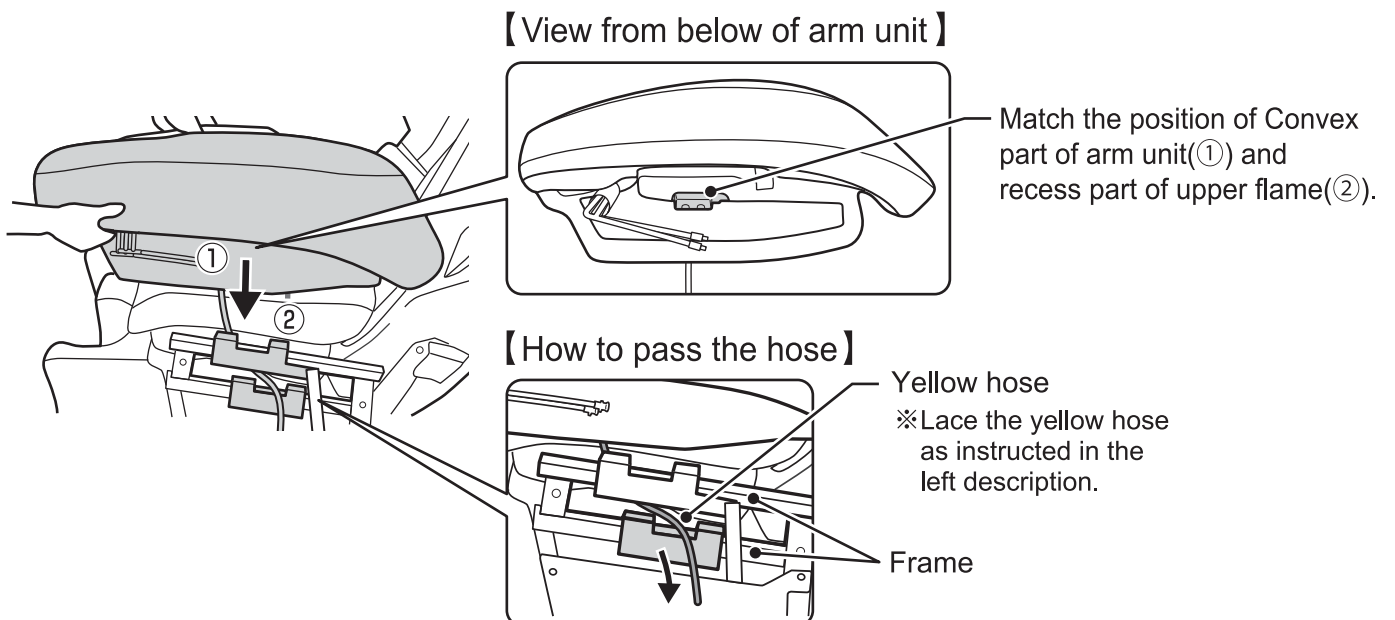

2. Connect the Arm unit hose (gray/black/yellow) matching with color of whole hose.

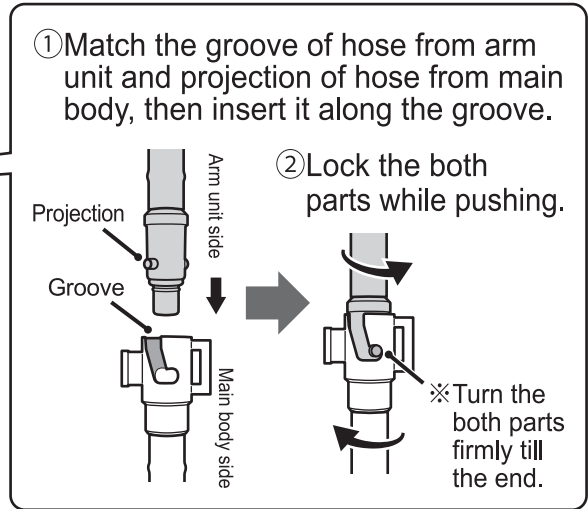
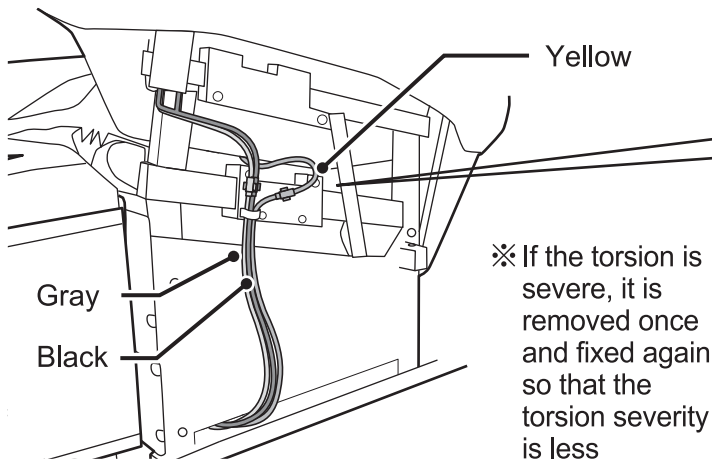

3. Screw the Arm unit.

The remote control stand is also screwed together during remote control stand fixation. When screwing them as follow.

①anteroinferior→②anterosuperior→③posterosuperioe

- Remote control stand is usually fixed in left hand side.
- Press the arm unit firmly toward to the frame and screw it.

[When Arm unit is only fixed]

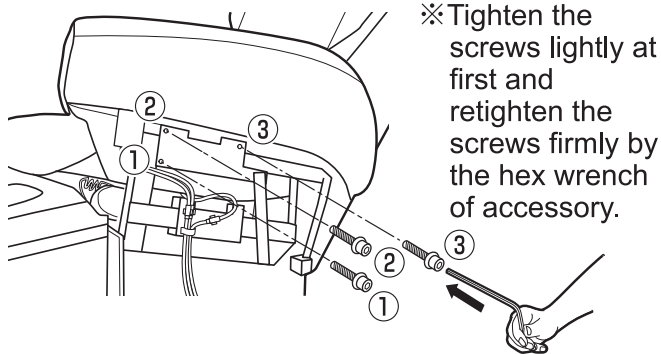

[When remote control stand is fixed]

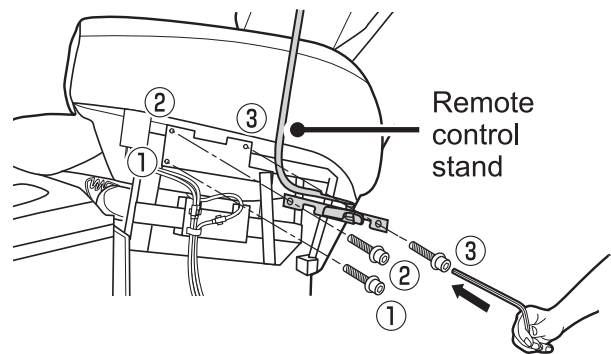

※When remote control stand is fixed in right hand side

- The following operation is carried out only when remote control stand is fixed in right hand side. This operation is not necessary if the remote control stand is fixed in left hand side.

- (1) Remove the base part screw of remote control stand.
- (2) The remote control stand is bent towards right and the screw is fixed in left screw hole.

(1) Remove the Screw.

※Enlarged image of remote control stand base part (Top view image)

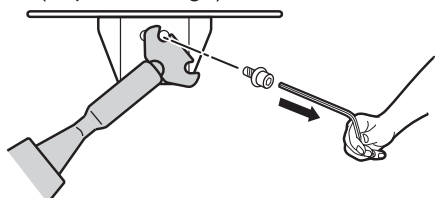

(2) The stand is bent towards right and screw is fixed by matching the right side dent to the left screw hole.

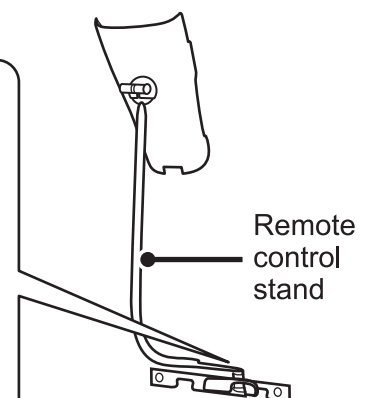
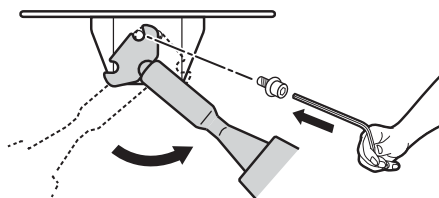

Fixing the arm rest

[Fixing of left armrest]

1. (1) Front side of left arm rest is matched with frame.
(2) Arm unit is matched to back side by lifting it.

※The arm unit should surely be lifted when matching it with the whole unit,
Failure to do so, then the arm unit will be in contact which may lead to damage.

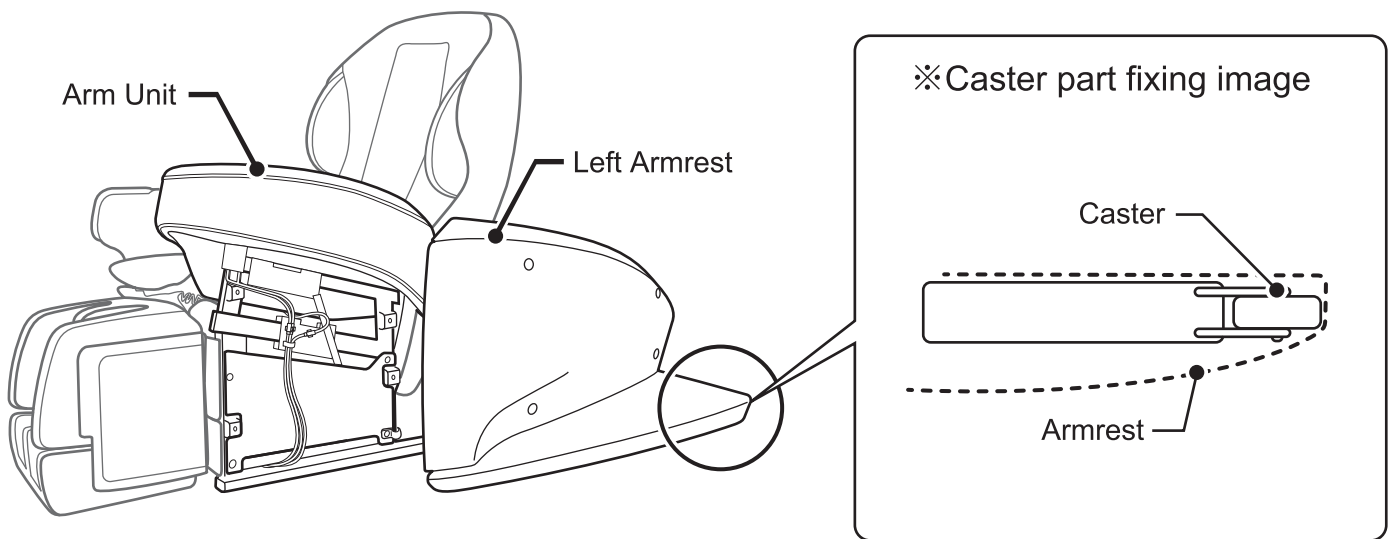

2. Firmly screw with armrest screw.

- The arm unit screw is temporary screwed with hex wrench in order (1)->(2)->(3)->(4) as shown in below image and again it is firmly screwed in the same order (1)->(2)->(3)->(4).
- The armrest gets removed if it is not screwed firmly and it may lead to accident or injury

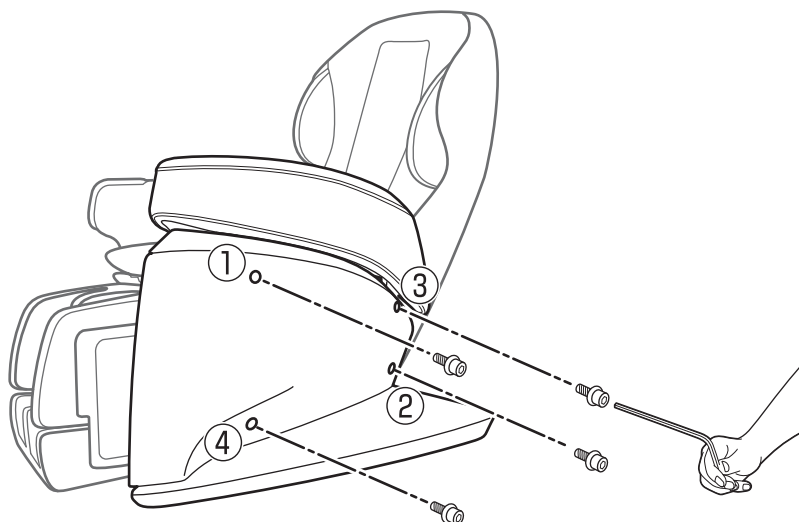

[Fixing of right armrest]

1. (1)The back side of right armrest should be matched with power switch BOX.
(2) Arm unit is matched to back side by raising it.

※The arm unit should surely be lifted when matching it with the whole unit.
Failure to do so then the arm unit will be in contact and may lead to damage.

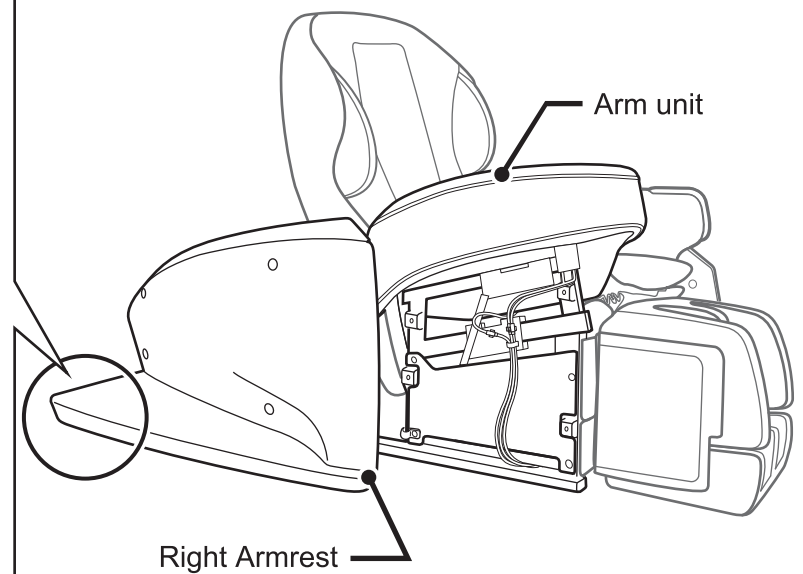
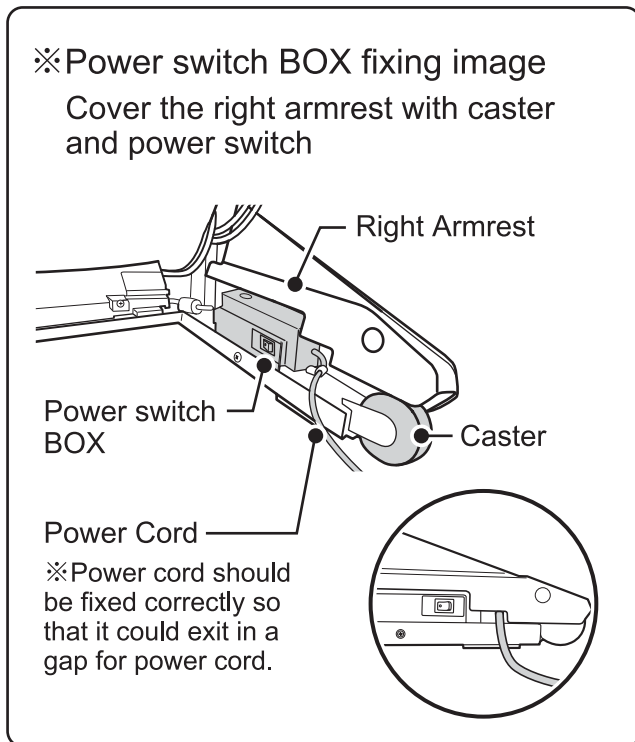

2. Firmly screw with armrest screw

- The arm unit screw is temporary screwed with hex wrench in order (1)->(2)->(3)->(4) as shown in below image, and again it is firmly screwed in the same order (1)->(2)->(3)->(4).
- The armrest gets removed if it is not screwed firmly and it may lead to accident or injury

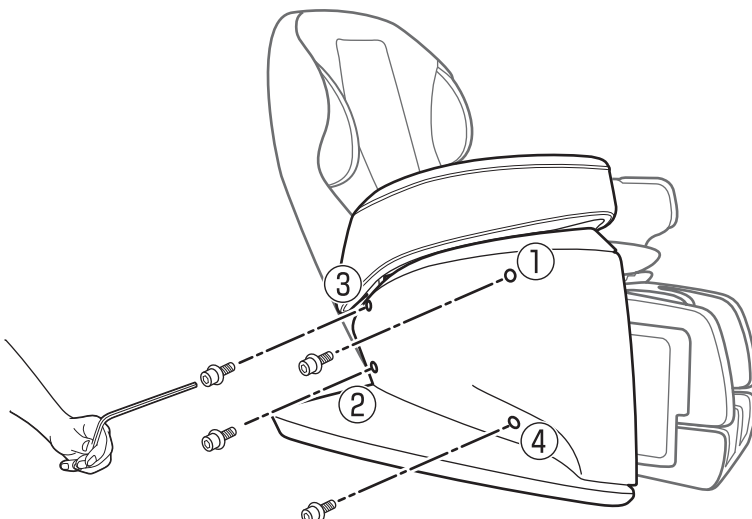

※After the installation of armrest, check if there is any dislocation in the back of armrest.

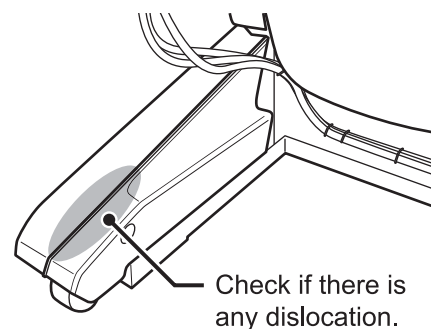

3. Fixing the Cap (Right/Left direction)

- Cap for fixing each hole is decided.
- Check the surface symbol of cap and fix it.
- When the cap is raised to the surface, check as there are possibilities of insertion mistakes.

※ Aim the marking part and match the dent part of the main unit with the cap side convex part and fix it.

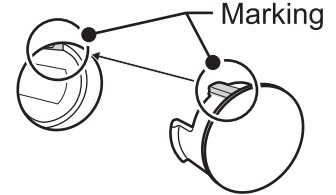

[For Left side]

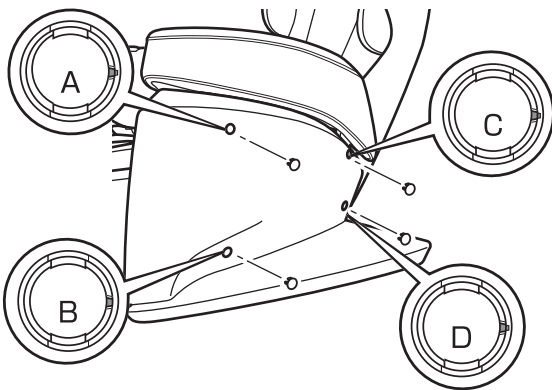

[For Right side]

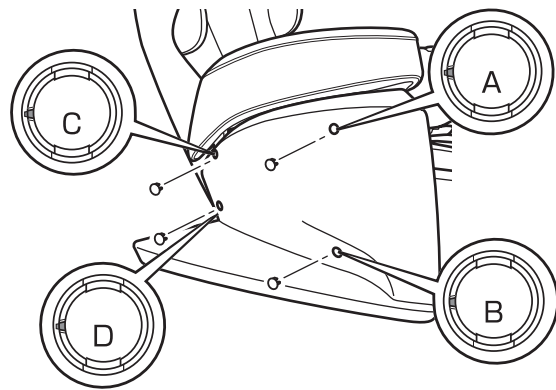

Fixing the Remote control

[Fixing method]

Remote control should be inserted from the top.

[Removing method]

Remote control should be pulled out from the top.

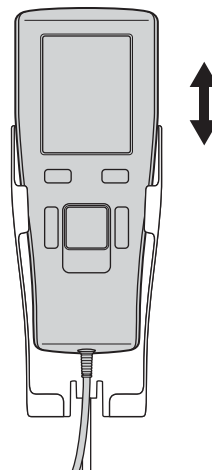

[Adjustment method of remote control holder]

Fixing screw is bent and fixed in preferred position.

※The remote control holder breaks if fixing screw is tightened strongly.

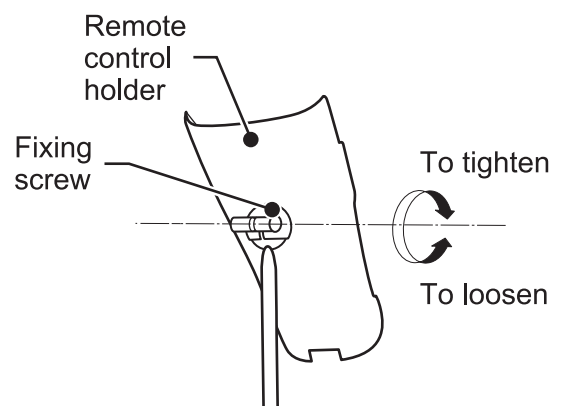

Attach the back pad and pillow

1. Attach the back pad in order of numbers.

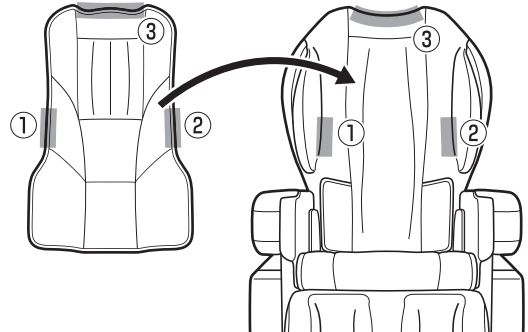

2. Pillow should be attached the surface fastener of back rest part

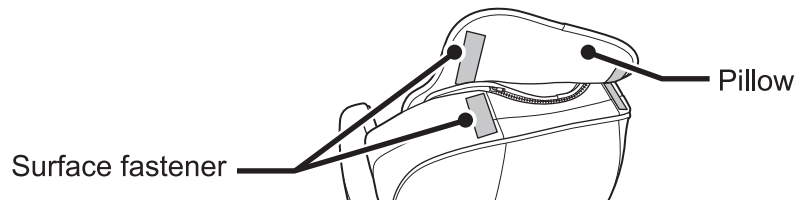

- When massage is performed, attach the back pad and rotate the pillow to the back side.
- When massage is felt as hard, attach the pillow and use it.
- When massage is not done, attach the back pad and pillow as such and use it as a reclining chair.

Before starting massage every time

Check around the chair

Check the surroundings without fail

- Check to make sure that there is nobody, no pet and nothing ahead behind the chair and under the footrest.

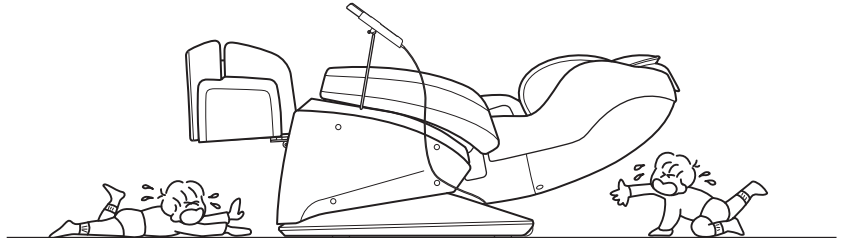

Switch on the power

! DANGER

Do not use the chair other than on the designated voltage. Fire or electrification may occur. Insert the power plug firmly so that no dust is accumulated. Failed to do so may cause electric shock, short circuit, or ignition. Do not use damaged power plug or power cord. It may cause electric shock, short circuit, or fire. If it is damaged, contact your retailer or our customer care for repair.

1. Insert the power cord plug in the receptacle.

- Check that there is no damage in the power cord, remote controller cord, and the power cord plug. And there is no dust accumulated in the power cord plug.

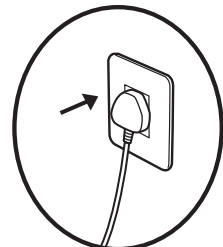



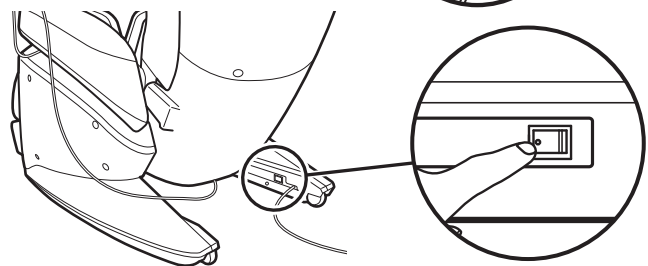

2. Switch "ON" power of main body.

- The power switch is behind the main body on the right bottom.



3. Press power button of remote controller to switch on the power.

- Regular screen is displayed.
- The seat back is reclined and footrest is raised till standby position automatically.
(When reclining angle of   or footrest angle of   or  is pressed, it is stopped)
- When it is not operated for around 3 minutes or more, power supply will be turned off automatically.

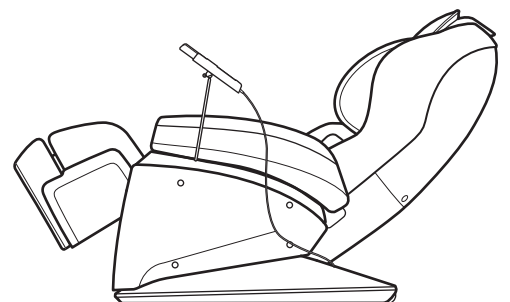

Standby position

- When regular screen is not displayed even if power is switched on by pressing the power button, the chair cannot be operated.

Check the main body

1. Check for torn on the cover cloth.

DANGER

Before use, hold the back pad and make sure that there is no tear on the cover cloth of the backrest and on the other parts. (Should there be any tear, no matter how small it is, discontinue using the chair immediately. Disconnect the power cord plug, and ask for repair.) Continued use with the torn cloth may cause electric shock or any hazard on the body.

2. Check for trapping of foreign substance to the main body.

WARNING

Before use, check that there is no foreign substance trapped on to the main body (Backrest, footrest, armrest). Failed to do so may cause accident or injury.

3. Check whether the knead ball is in the retracted position.

- When the knead ball is not in the retracted position, it can be returned by pressing  button.

WARNING

Before seated on the chair, check whether the knead balls are in the retracting position. Failed to do so may cause accident and injury.

4. Check whether the footrest is in completely lowered

- When the footrest is raised, it can be lowered down by pressing footrest angle .

WARNING

Do not get on and off the chair at the time of reclining or when the footrest is raised. The chair may overturn and the user may fall down and hurt himself/herself.

Adjust the reclining and footrest angle

DANGER

Check to make sure that there is nobody, no pet and nothing ahead around the chair (back, front, side, and bottom part of main body) when reclined or footrest is moved. Failed to do so may cause accident or injury or damage of house holding.

When reclined or footrest is moved, make sure not to insert the hand, finger, leg or head in the gaps of main body which are mentioned below.

- Bottom side of chair • Gap of armrest, backrest, and seat. • Gap of armrest, leg and seat .
- Bottom side and back side of leg. • Gap of armrest and arm. • Backside gap of backrest.



Failed to do so may cause accident or injury

Adjust the footrest angle and length

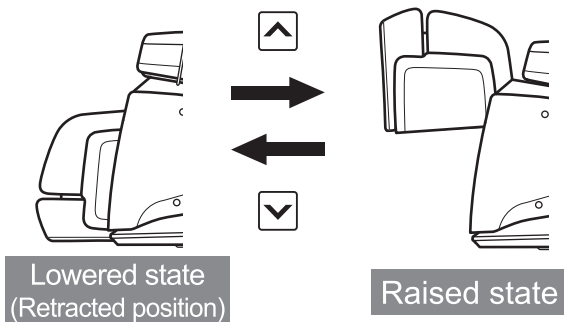
1. Adjust the footrest angle by pressing footrest angle   button.



- When foot air is on, footrest will not be lowered till the retracted position
- Turn "OFF" the footrest air to lower the footrest till retracted position. (Refer Page35)

2. Adjust the footrest length by pressing the   footrest expansion buttons.

- Flexibility function can be used when footrest angle is 25 degree or more.
- Footrest length to be stretched changes in accordance with footrest angle.

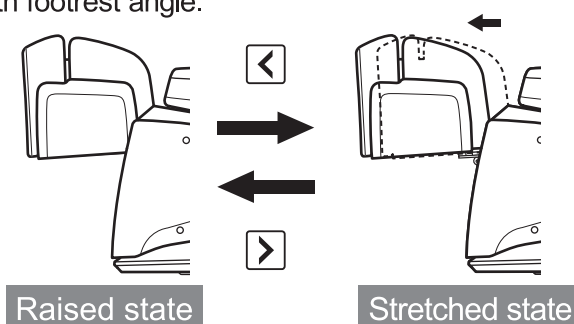

3. Stretch the sole and adjust the footrest length.

- Sole can be stretched or contracted by the spring. Press it with the leg.

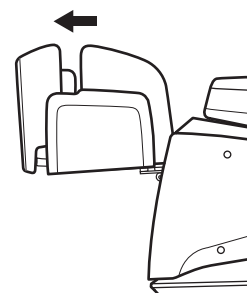
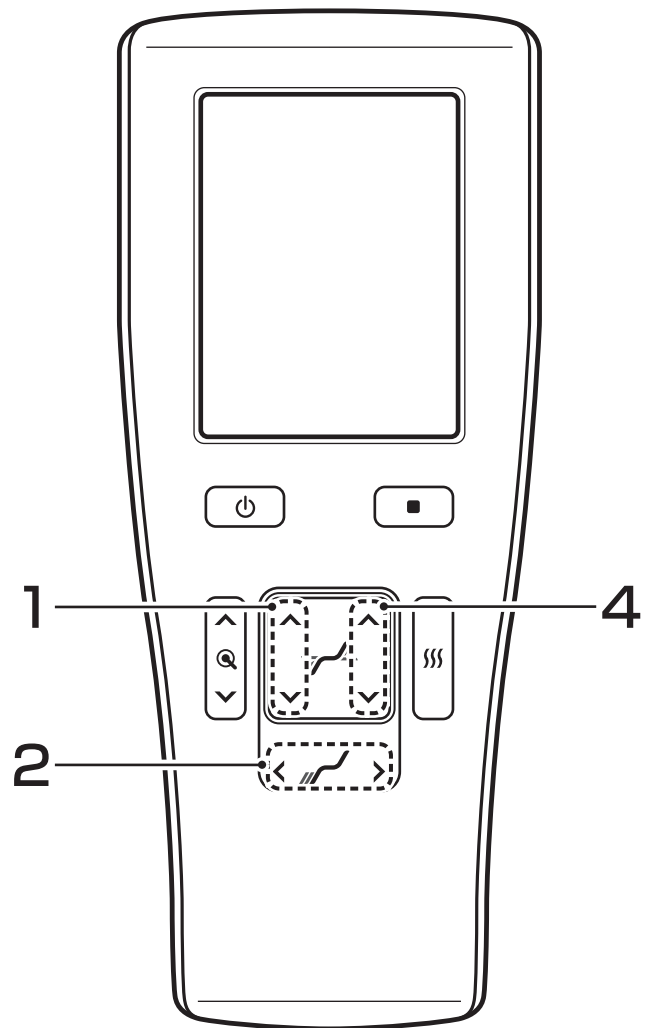

WARNING

Do not place your leg or hand in the footrest adjustable place, when footrest is adjusted. It may cause accident or injury.

Do not attempt to ride on the front portion of footrest or seat pad at the time of reclination.

The chair may overturn and the user may fall down and hurt himself/herself.

Do not get on and off the chair at the time of reclining or when the footrest is raised.

The chair may overturn and the user may fall down and hurt himself/herself.

How to adjust reclining angle

4. The Reclining angle can be adjusted by pressing   reclining button..

- Rather than falling down, irritability of the knead ball will be more.
- The recliner is interlocked, the footrest raises and armrest moves.

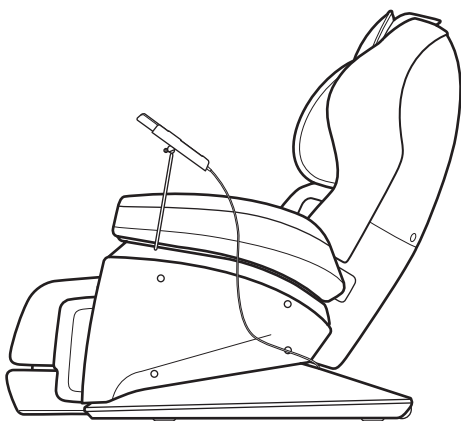

Upright Position

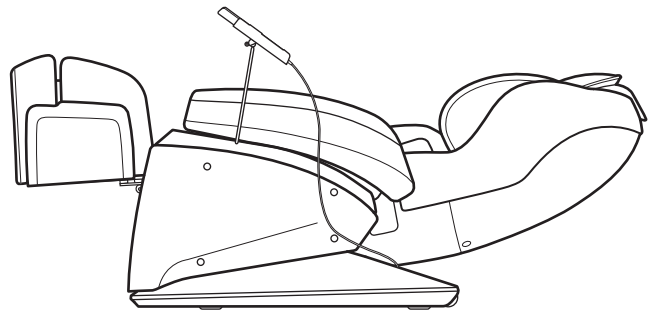
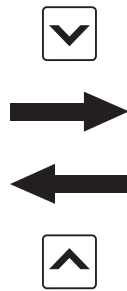





Backward Position

Massage by Auto Mode Course

Auto Mode Course starts

1. Switch ON the Power by pressing

- Regular screen is displayed.
- The seat back is reclined and footrest raises automatically up to the standby position.
(When reclining angle of   or footrest angle of   or  is pressed, it is stopped)
- If the machine is not operated for more than 3 minutes, then it is switched OFF automatically.

2. Select and press from these

     Buttons.

Choose the preferred course and press the button.

- When the backrest is upper or footrest is lower than standby position, the backrest and footrest move to standby position.

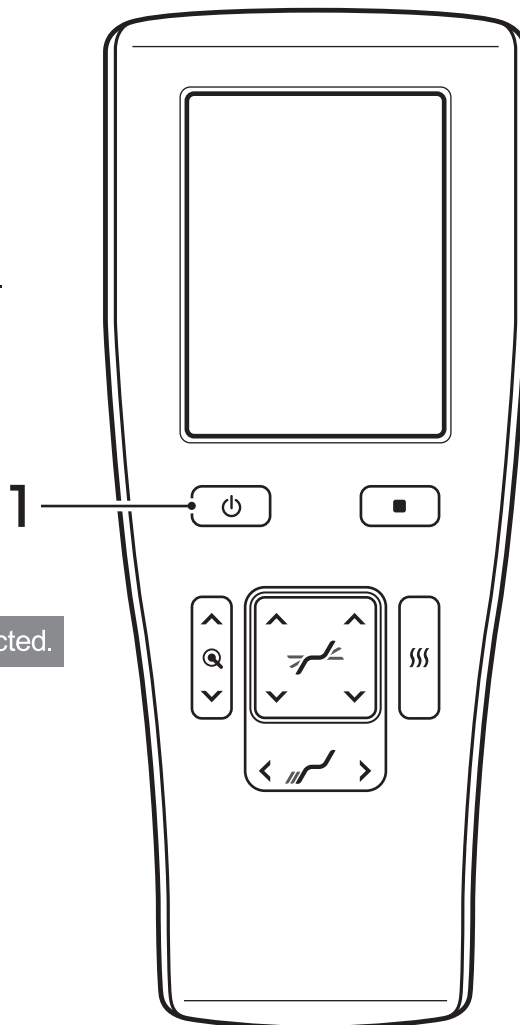

[Example] When "REFRESH" course of Neck/Shoulder is selected.

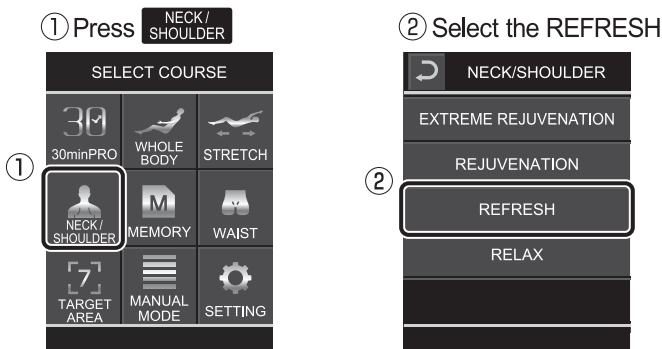

3. Start the Double Sensing (Body Shape Detection)

- Sit back firmly and lean the head towards backrest while sensing.
- Do not pull head off the backrest.
- There are some courses that the sensing is not given.

About Double Sensing (Body Shape Detection)

Double sensing is the function to detect body shape or posture before starting massage. The effective massage is given by 2 sensors, one for 「S-shaped line detecting system」 which detect one's back/spine, another for 「Shoulder position detecting system」 which detect one's shoulder position.

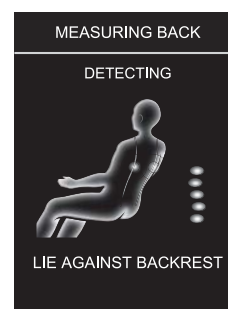

4. Detected points lights up during the detection of back/spine

- Do not keep head away from the backrest.

[DETECTION COMPLETE]

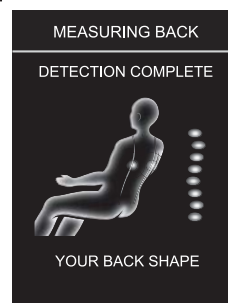

[ERROR]

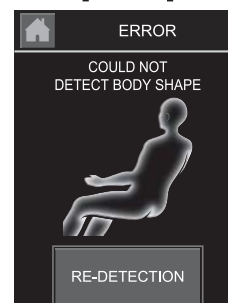

5. Detection for shoulder position automatically starts

After finishing detection, the selected course starts by pressing 「START(①)」. When shoulder position doesn't match, adjust by 「RE-DETECTION(②)」 or 「MANUAL ADJUSTMENT(③)」.

- Even if 「START」 is not pressed, the massage starts after about 7 seconds.
- Detection starts again when press 「RE-DETECTION」.
- Shoulder position can be adjusted by pressing [MANUAL ADJUSTMENT] during or after the detection. Adjust ▲ ▼ (④) for vertical position, ◀ ▶ for back and forward position, then press OK (⑥).
- Shoulder position detection measures vertical position. back and forward position can be adjusted by 「MANUAL ADJUSTMENT」 or Shoulder position adjustment after starting massage.

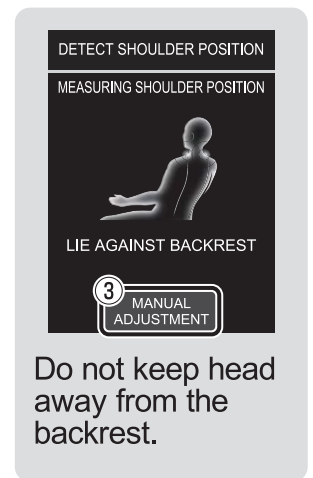

[DETECTION COMPLETE] [MANUAL ADJUSTMENT]

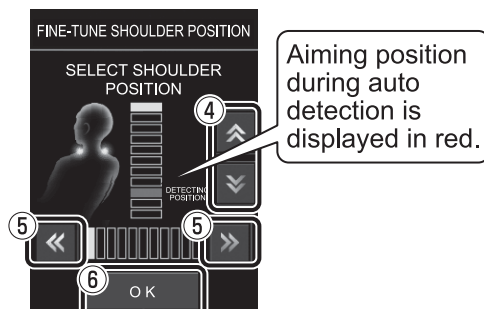
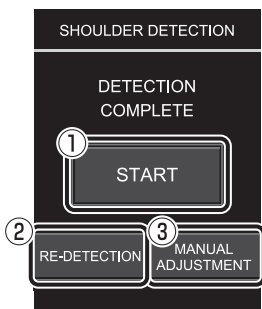

Aiming position during auto detection is displayed in red.

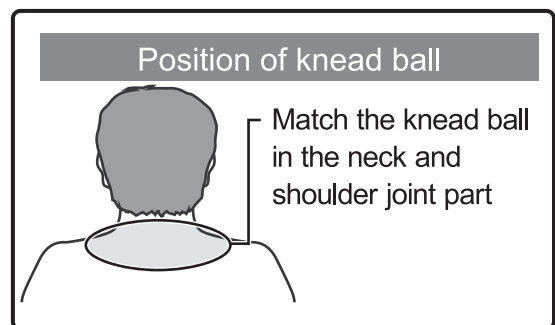

6. Selected auto course and massage operations are displayed.

[Display Example]

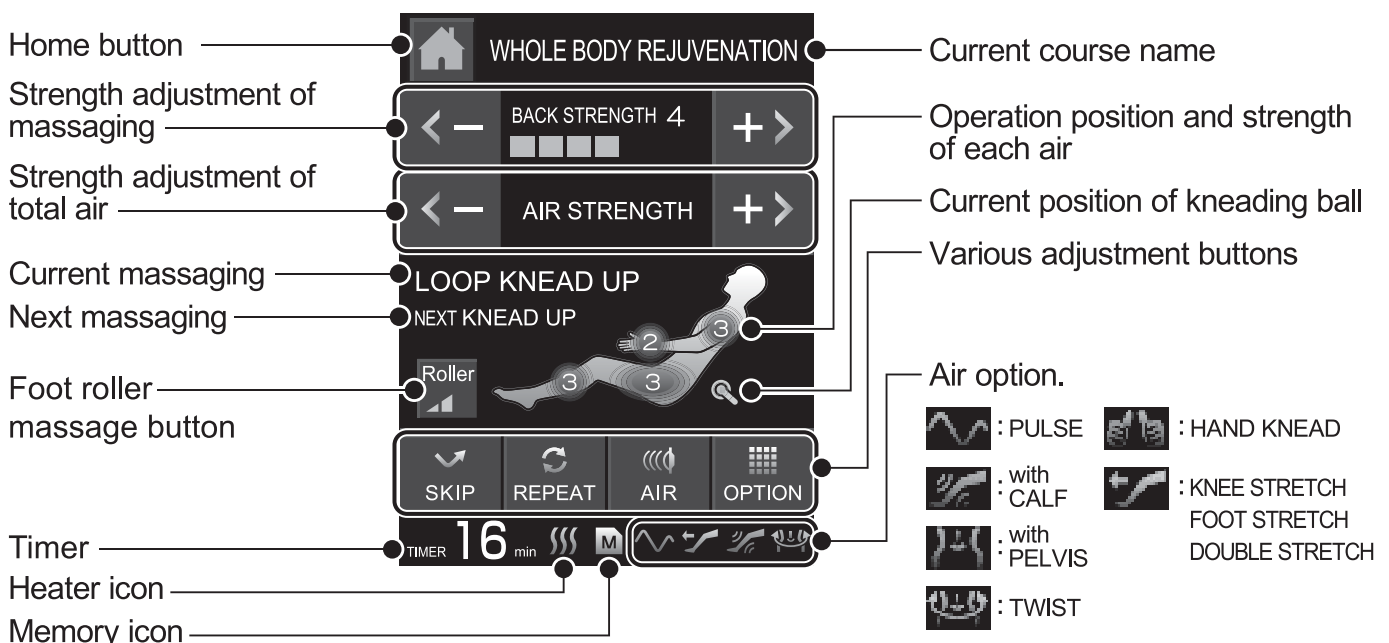

- Refer to "Adjustment during auto course method" for the changes done in the settings during auto course. (P24)

Adjustment during auto course method

To adjust the strength of mecha massage

① Adjust the back strength by using **+>** for increase and by using **<-** for decrease.

- Strength can be selected from 7 steps.
- The initial setting is set in “4”.

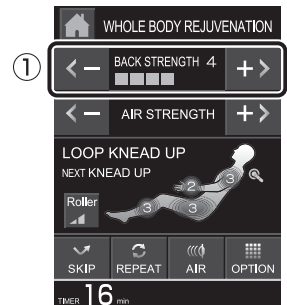

Adjustment method during air massage

[In the case whole adjustment]

① Total Air strength can be reduced with **<-** and increased with **+>**.

[In the case part by part adjustment]

- ① Press the “AIR”
- ② Select the preferable strength part by part.
Can be reduced with **<-** and increased with **+>**.
- ③ Return to course screen by pressing **OK**
 - Even if **OK** is not pressed, it will be set after 7 seconds approximately.
 - Strength can be selected such that SHOULDER, PELVIS, FOOT...5 step adjustment and ARM... 3 step adjustment. The default setting will be [SHOULDER, PELVIS, FOOT 3] and [ARM 2].
 - “OFF” can be set in part wise. If the **<-** is pressed when the strength is “1”, it will be set to “OFF”.

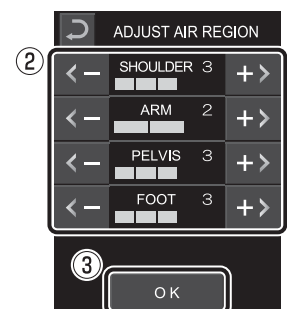
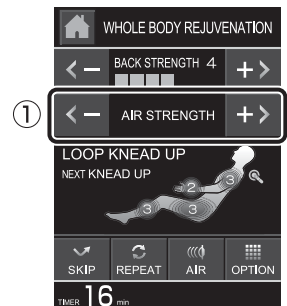

To proceed from current knead massage and to repeat the current knead massage

- ① When you want proceed from current knead massage, and press “SKIP”
- ② When you want repeat from current knead massage, and press “REPEAT”
 - Air massage cannot skip and repeat.
 - While pressing the repeat , the current massage will be continued for 30 seconds.
 - During repeat , if press skip the repeat will be released.

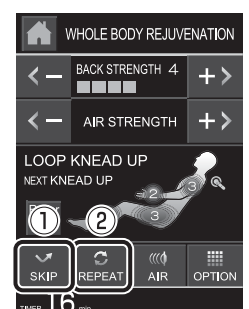

To adjust the shoulder position (Front/back) and waist position (Up/down)

- ① When the mecha position come near by the shoulder or waist, press the of mecha position
- ② The mecha position is adjusted by using (front/back position of shoulder) or (Waist position).
- ③ Press **OK**
 - Even if is not pressed, it will be set after 7 seconds approximately.
 - The front back position of shoulder/ waist position will be reflected in neck and shoulder pro technique/ back and waist pro technique.

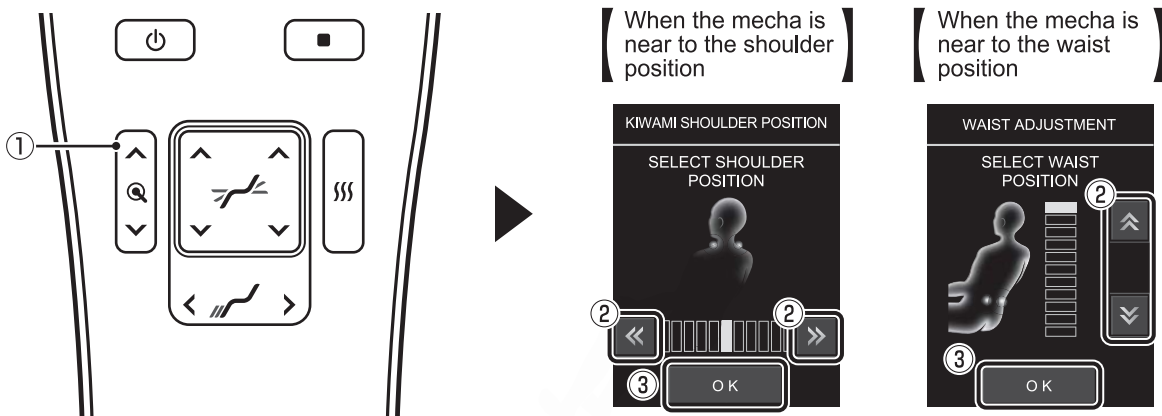

To set air operation “PULSE” and “HAND KNEAD”

- ① Press “OPTION”
- ② Select “OFF / PULSE / HAND KNEAD”
- ③ Return to course screen by pressing **OK**
 - Even if **OK** is not pressed, it will be set after 7 seconds approximately.
 - PULSE and HAND KNEAD cannot be used simultaneously.

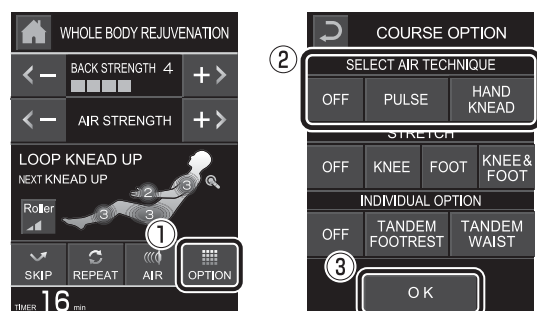

To set stretch operation

- ① Press "OPTION".
- ② Select "OFF / KNEE / FOOT / KNEE&FOOT".
- ③ Return to course screen by pressing **OK**.

- Even if **OK** is not pressed, it will be set after 7 seconds approximately.
- When the stretch operation is selected, if the foot rest top angle is less, operation will begin after raising stretch operation up to possible angle.
- Multiple stretch operations cannot be set simultaneously.
- Stretch operation and "CALF" cannot be set simultaneously.

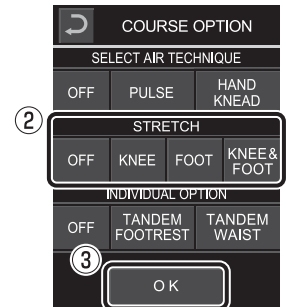

To set individual operation

- ① Press "OPTION".
- ② Select "OFF / TANDEM FOOTREST / TANDEM WAIST".
- ③ Return to course screen by pressing **OK**.

- Even if **OK** is not pressed, it will be set after 7 seconds approximately.
- "CALF" with "PELVIS" cannot be set simultaneously.
- "CALF" and stretch operation cannot be set simultaneously

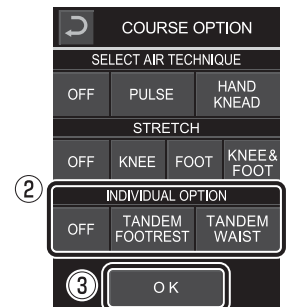

To adjust foot roller massage

- ① Each time you press [Roller] button, Strength changes from [3]→[OFF]→[1]→[2]→[3]

- Even Default setting of strength is [2].
- Refer to [Foot roller massage].

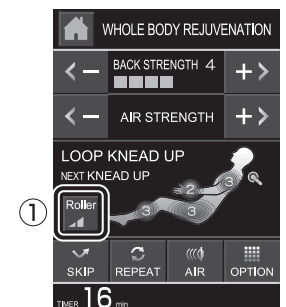

About the operation of auto course

The list of details that can be adjusted during the description of each auto course and during the start or in the middle of the course.

Course	Course details	Spinal column line auto detect	Shoulder auto detect	Rubbing ball	Air massage strength	Skip/repeat	Adjust the shoulder position	Adjust the waist position	Option	
30min PRO	VIP	Rejuvenating	●	●	●	●	-	●	●	-
	ELITE THERAPY	Perfect	●	●	●	●	-	●	●	-
	SLOW STRETCH	Refreshing	-	●	●	●	-	●	-	-
	AIR RELAX	Relaxing	-	-	-	●	-	-	-	-
WHOLE BODY	DEEP REJUVENATION	Rejuvenating	●	●	●	●	●	●	●	●
	REJUVENATION	Perfect	●	●	●	●	●	●	●	●
	REFRESH	Rhythmical	●	●	●	●	●	●	●	●
	RELAX	Refreshing	●	●	●	●	●	●	●	●
	SOFT	Light massage	●	●	●	●	●	●	●	●
NECK/SHOULDER	DEEP REJUVENATION	Rejuvenating	●	●	●	●	●	●	●	●
	REJUVENATION	Perfect	●	●	●	●	●	●	●	●
	REFRESH	Rhythmical	●	●	●	●	●	●	●	●
	RELAX	Refreshing	●	●	●	●	●	●	●	●
WAIST	DEEP REJUVENATION	Rejuvenating	●	●	●	●	●	●	●	●
	REJUVENATION	Perfect	●	●	●	●	●	●	●	●
	REFRESH	Rhythmical	●	●	●	●	●	●	●	●
	RELAX	Refreshing	●	●	●	●	●	●	●	●
STRETCH	DEEP WHOLE BODY STRETCH	Rejuvenating	-	●	●	●	-	●	-	-
	WHOLE BODY STRETCH	Perfect	-	●	●	●	-	●	-	-
	WHOLE BODY AIR	Massage only with air	-	-	-	●	-	-	-	●
MEMORY	Initially WHOLE BODY REJUVENATION course is being registered.									

※Spinal column line cannot be adjusted

About the end of Massage

Massage time is different from each course

- The knead ball moves to storing position after finishing massage.
- When auto reclining is 「OFF」, return the angle of backrest and footrest to storing position during 「STORING」is shown on the display.
- When auto reclining is 「ON」, backrest moves up and footrest moves down automatically.
- When no operation for about 30 seconds after massage, power supply will be cut.

Course Selection	Massage time
Part massage	7 minutes
Auto Course Manual Course	16 minutes
30 min PRO course	30 minutes

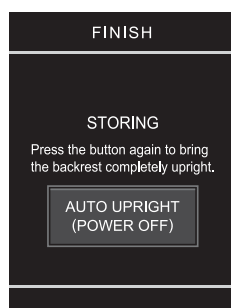

⬆️ ⬇️ : Reclining angle

⬆️ ⬇️ : Footrest angle



When massage is stopped as such

Press  (①) or  (②)

- The knead ball is stopped in the current position as such
- If  or  is pressed you will return to regular screen but the timer will continue.

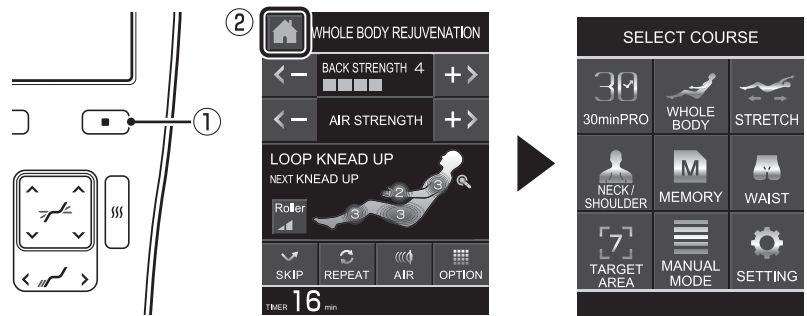

When massage is to be stopped suddenly

Press 

- Knead ball moves till retracting position
- When "STORING" screen is displayed then restore the recliner and angle of footrest

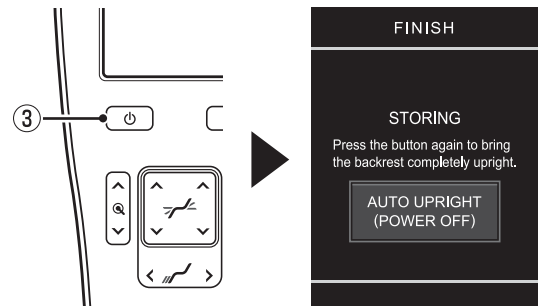
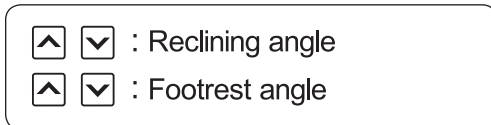

Disconnect the power of Main Body

1. Switch OFF the power of the main body

- The power switch is in the lower right part behind the main body.

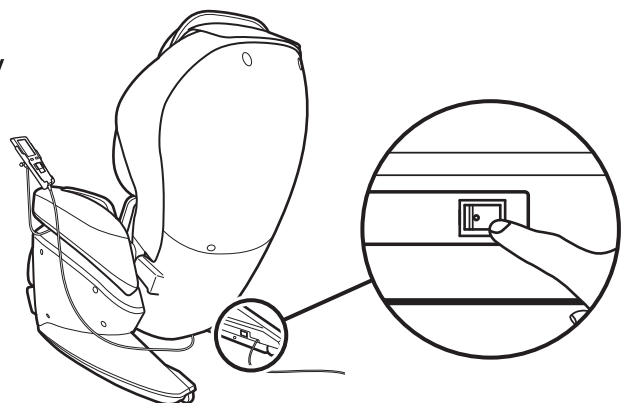



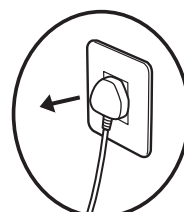

2. Remove the Power cord plug from receptacle



Rubbing massage

Start the desired rubbing massage

1. Switch ON the Power by pressing

- Regular screen is displayed.
- The seat back is reclined and footrest raises automatically up to the standby position.
(When reclining angle of   or footrest angle of   or  is pressed, it is stopped)
- If the machine is not operated for more than 3 minutes, then it is switched OFF automatically.

2. Select .

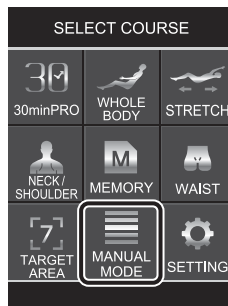

3. Select the desired massaging menu.

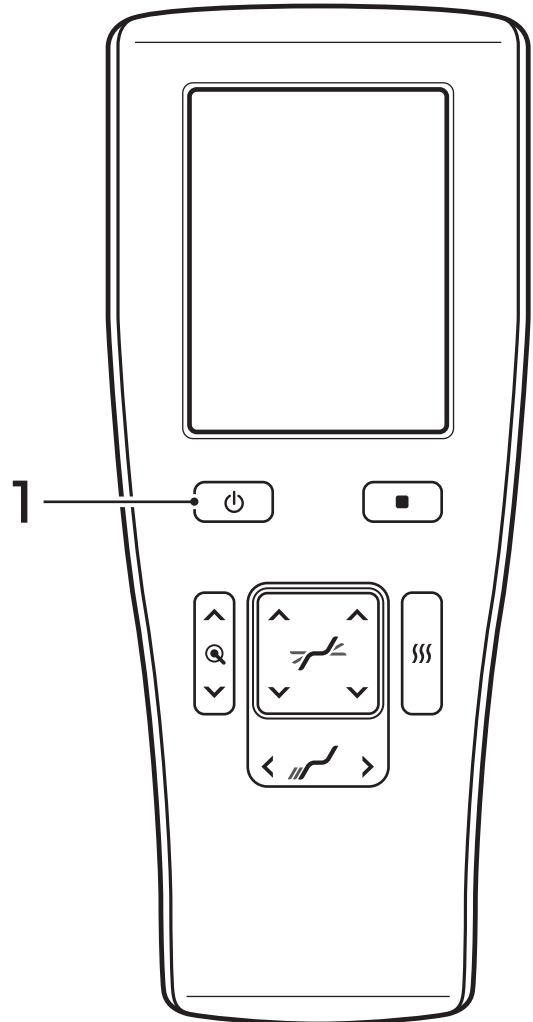
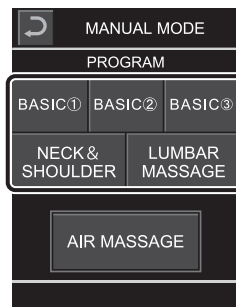

4. Select the desired massaging.

- Start the Massage

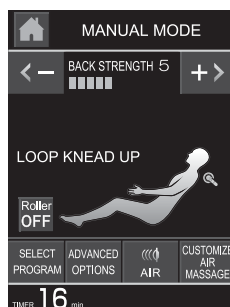
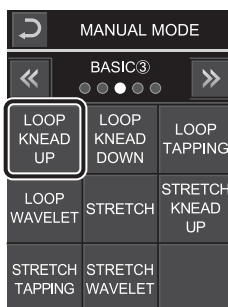

5. Mecha position (Shoulder position or Waist position) Adjustment.

Refer "Knead technique function list" for the massage in which mecha can be adjusted.

[Shoulder position adjustment]

- The mecha is moved to shoulder position and shoulder position detection starts. After completing detection, Massage starts if "START (1)" is pressed. When the shoulder position is not matching adjust using "RE-DETECTION (2)" or "MANUAL ADJUSTMENT (3)".
- Even if "START" is not pressed, it will be started after 7 seconds approximately.
- The shoulder detection starts once again if "Redetect" is pressed.
- Shoulder position is manually adjusted if "MANUAL ADJUSTMENT" is pressed. Up/Down position of Mecha is adjusted by (4), Front/Back position is adjusted by (5) Press (6).

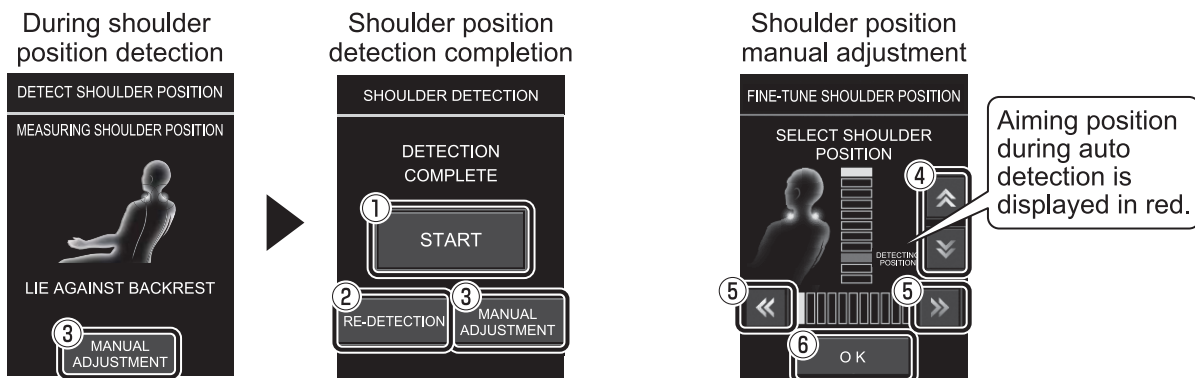

- Press the rubbing ball position (7) first, then use (8) to adjust the shoulder position front/back during massage. Press (9) after shoulder position adjustment.

[Waist position adjustment]

- Waist position is adjusted with rubbing ball position (7) or (10). Press (11) after waist position adjustment.

[Massage position adjustment]

- Adjust the massage position using (7) of mecha position.

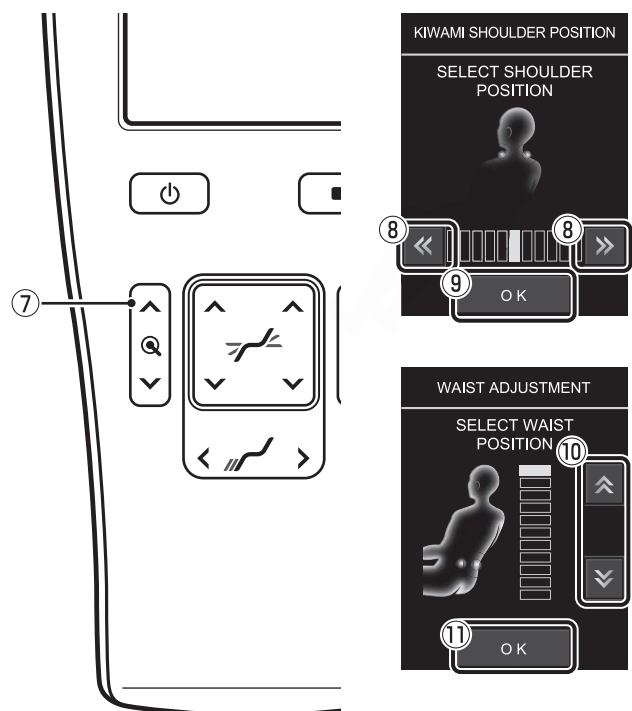

How to adjust during massaging

When you want to adjust the massage speed

- ① Select the "ADVANCED OPTIONS".
- ② Select the speed "SLOWEST/SLOW/NORMAL/FAST".
- ③ Press **OK**.

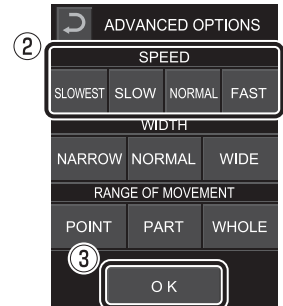
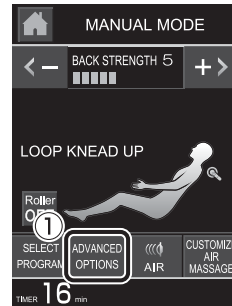

When you want to adjust the rubbing ball strength

- ① Select the "ADVANCED OPTIONS".
- ② Rubbing width adjustment
Select the "NARROW/NORMAL/WIDE".
- ③ Press **OK**.

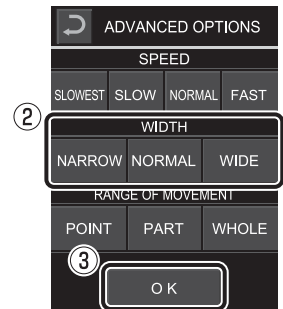
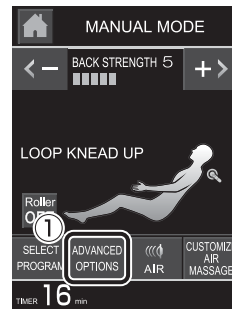

When you want to select the massage region (Point/part/whole)

- ① Select the "ADVANCED OPTIONS".
- ② Select the speed "POINT/PART/WHOLE".
- ③ Press **OK**.

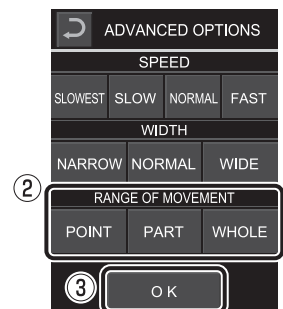
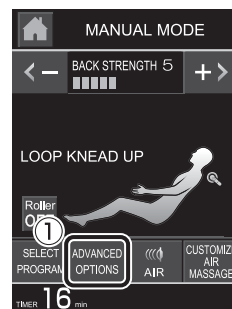

To adjust the shoulder position (Front/back) and waist position (Up/down)

- ① Knead ball position is pressed when mecha is near shoulder or waist.
 - ② Knead ball position is adjusted with (Shoulder front and back position) or (neck position).
 - ③ is pressed.
- Even if is not pressed, it will be started after 7 seconds approximately.
 - The shoulder front and back position/Waist position is reflected in neck and shoulder position/Back and waist position. Refer to "Mecha massage function list table" for details. (P34)

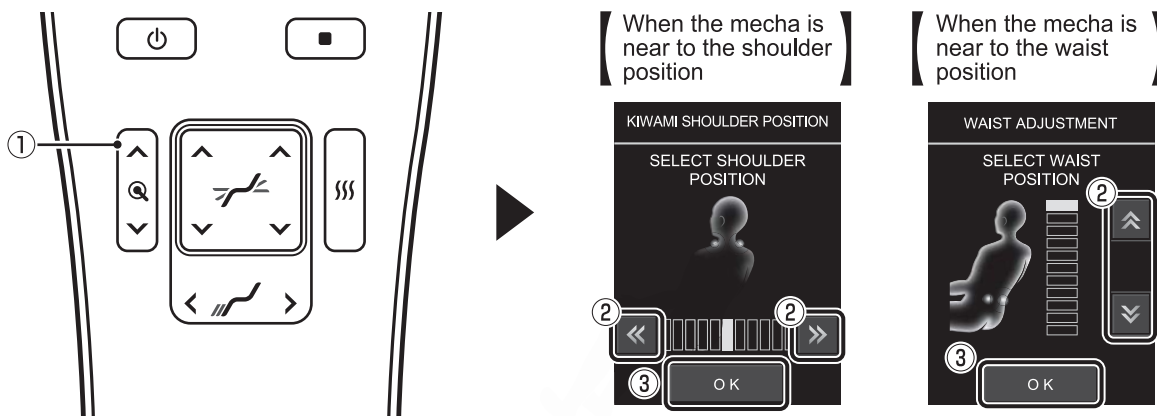

To adjust the strength of mecha massage

- ① Adjust the back strength by using for increase and by using for decrease.
- Strength can be selected from 12 steps.
 - The initial setting is set in "5".

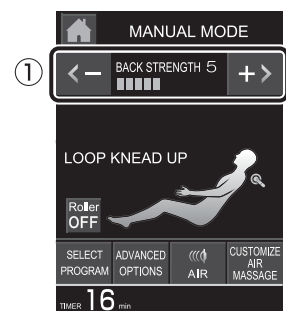

- There is an item which cannot perform Adjustment/Setting by selected rubbing technique. Refer "Mecha massage function list table" for details.

Mecha massage function list table





The list of adjustments that can be performed during each knead technique.

	PROGRAM	knead technique adjustment	Knead technique front and back adjustment	Mecha Strength	Massage speed	Mecha width	Combination of foot roller	Massage position
BASIC ①	KNEAD UP	-	-	●	●	-	●	WHOLE/PART/POINT
	KNEAD DOWN	-	-	●	●	-	●	WHOLE/PART/POINT
	TAPPING	-	-	●	●	●	●	WHOLE/PART/POINT
	WAVELET	-	-	●	●	-	●	WHOLE/PART/POINT
	RELAX KNEAD UP	-	-	●	●	-	●	-
	RELAX KNEAD DOWN	-	-	●	●	-	●	-
	PUSH & KNEAD	-	-	●	●	-	●	WHOLE/PART/POINT
	PALM KNEAD UP	-	-	●	-	-	●	WHOLE/PART/POINT
	PALM KNEAD DOWN	-	-	●	-	-	●	WHOLE/PART/POINT
BASIC ②	SHIATSU	-	-	●	-	●	●	WHOLE/PART/POINT
	SHIATSU STRETCH	-	-	●	-	●	●	WHOLE/PART/POINT
	INNER BACK	shoulder position	●	●	●	-	●	-
	ROLLING	shoulder position	●	●	-	●	●	PART/POINT
	WAVE ROLLING	shoulder position	●	●	●	-	●	PART/POINT
	3D KNEAD UP	-	-	-	-	-	●	WHOLE/PART/POINT
	3D KNEAD DOWN	-	-	-	-	-	●	WHOLE/PART/POINT
	3D TAPPING	-	-	-	-	●	●	WHOLE/PART/POINT
3D WAVELET	-	-	-	-	-	●	WHOLE/PART/POINT	
BASIC ③	LOOP KNEAD UP	-	-	●	●	-	●	WHOLE/PART/POINT
	LOOP KNEAD DOWN	-	-	●	●	-	●	WHOLE/PART/POINT
	LOOP TAPPING	-	-	●	●	-	●	WHOLE/PART/POINT
	LOOP WAVELET	-	-	●	●	-	●	WHOLE/PART/POINT
	STRETCH	-	-	●	-	●	●	WHOLE/PART/POINT
	STRETCH KNEAD UP	-	-	●	●	-	●	WHOLE/PART/POINT
	STRETCH TAPPING	-	-	●	●	●	●	WHOLE/PART/POINT
	STRETCH WAVELET	-	-	●	●	-	●	WHOLE/PART/POINT
NECK / SHOULDER	NECK RELAX	shoulder position	●	-	-	-	●	-
	NECK SHIATSU	shoulder position	●	-	-	-	●	-
	NECK KNEAD	shoulder position	●	-	-	-	●	-
	NECK / SHOULDER DEEP KNEAD	shoulder position	●	-	-	-	●	-
	NECK / SHOULDER DEEP TAPPING	shoulder position	●	-	-	-	●	-
	SHOULDER TAPPING	shoulder position	●	-	-	-	●	-
	UPPER SHOULDER PRESS	-	-	-	-	-	●	-
BACK / WAIST	WAIST DEEP KNEAD	waist position	-	-	-	-	●	-
	WAIST DEEP TAPPING	waist position	-	-	-	-	●	-
	LUMBAR SHIATSU	waist position	-	-	-	-	●	-
	PALM TECHNIQUE (WAIST)	waist position	-	●	-	-	●	-
	BUTTOCK	-	-	-	-	-	●	-
	SHOULDER BLADE LINE	shoulder position	-	●	-	-	●	-
	INNER BACK SHOULDER	shoulder position	●	●	-	-	●	-
	SHOULDER BLADE OPEN	shoulder position	●	●	-	-	●	-

Air massage

Start air massage

1. Switch ON the Power by pressing



- Regular screen is displayed.
- The seat back is reclined and footrest raises automatically up to the standby position.
(When reclining angle of   or footrest angle of   or  is pressed, it is stopped)
- If the machine is not operated for more than 3 minutes, then it is switched OFF automatically.

2. Select

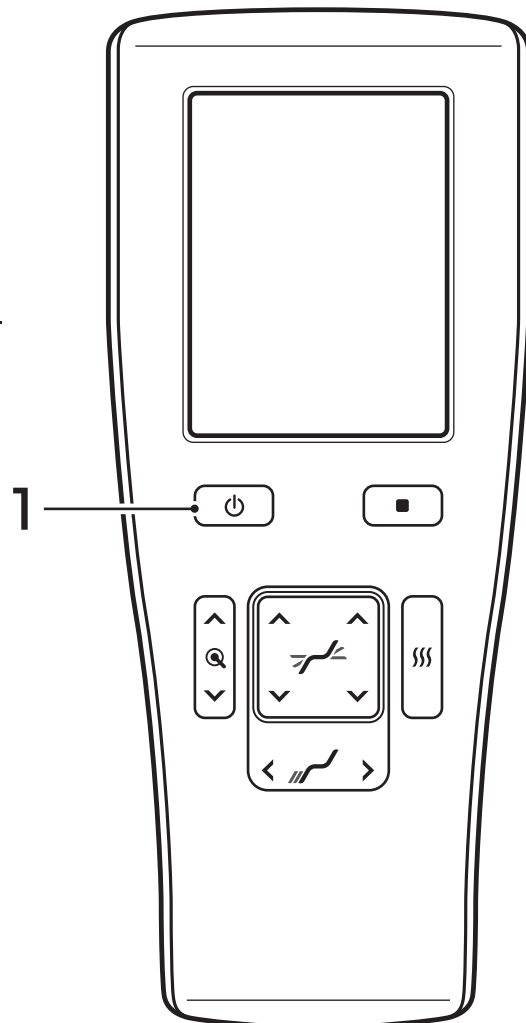
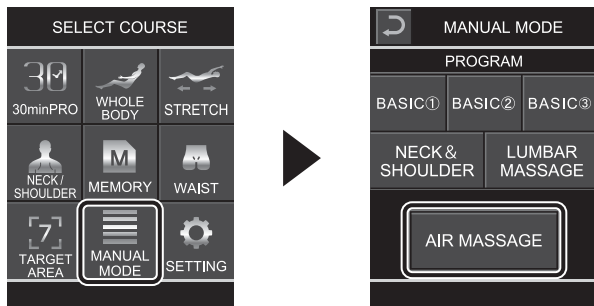
3. Select "AIR MASSAGE"



4. Select the desired strength press

- The air strength of "SHOULDER", "ARM", "PELVIS", "FOOT" can be selected individually
Can be reduced with  and increased with 
Press  and start the massage
- The Footrest does not go down to standby position while using foot air or foot roller.
- Turn the foot air and foot roller 「off」 and lower the footrest when you want to lower the footrest to the standby position.

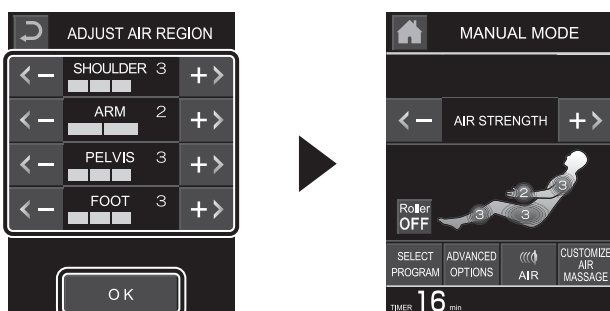

How to adjust during massaging

Adjustment method during air massage

[In the case whole adjustment]

- ① Total Air strength can be reduced with **←** and increased with **→**.

[In the case part by part adjustment]

- ① Press the “AIR”
- ② Select the preferable strength part by part.
Can be reduced with **←** and increased with **→**.
- ③ Return to course screen by pressing **OK**
 - Even if **OK** is not pressed, it will be set after 7 seconds approximately.
 - Strength can be selected such that SHOULDER, PELVIS, FOOT...5 step adjustment and ARM... 3 step adjustment. The default setting will be [SHOULDER, PELVIS, FOOT 3] and [ARM 2].
 - “OFF” can be set in part wise. If the **←** is pressed when the strength is “1”, it will be set to “OFF”.

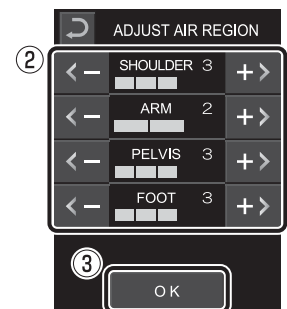
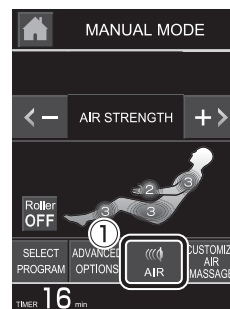
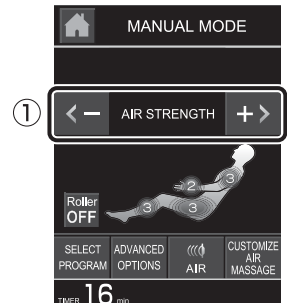

To set stretch operation

- ① Press “CUSTOMIZE AIR MESSAGE”.
 - ② Select “OFF / KNEE / FOOT / KNEE&FOOT”.
 - ③ Return to course screen by pressing **OK**.
- Even if **OK** is not pressed, it will be set after 7 seconds approximately.
 - If the stretch is set to “ON”, when leg air in “OFF”, leg air will be set to “ON” automatically.
 - When the stretch operation is selected, if the foot rest top angle is less, operation will begin after raising stretch operation up to possible angle.
 - Multiple stretch operations cannot be set simultaneously.
 - Stretch operation and “CALF” cannot be set simultaneously.
 - Refer to P37, for various stretch operation details

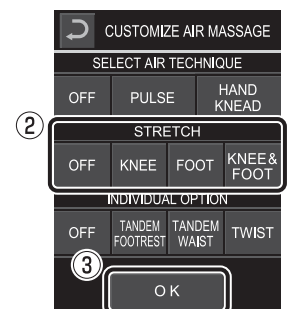
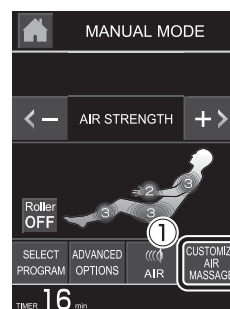

To set air operation “PULSE” and “HAND KNEAD”

- ① Press “CUSTOMIZE AIR MESSAGE”.
- ② Select “OFF/PULSE/HAND KNEAD”
- ③ Return to course screen by pressing **OK**

- Even if **OK** is not pressed, it will be set after 7 seconds approximately.
- PULSE and HAND KNEAD cannot be used simultaneously.

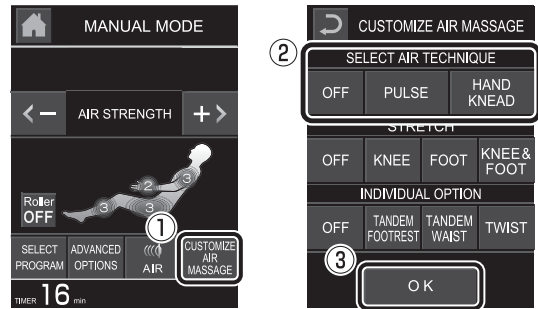

To set individual operation

- ① Press “CUSTOMIZE AIR MESSAGE”.
- ② Select “OFF/TANDEM FOOTREST/TANDEM WAIST/TWIST”.
- ③ Return to course screen by pressing **OK**

- Even if **OK** is not pressed, it will be set after 7 seconds approximately.
- If the “CALF” is set to “ON” when the leg air is “OFF”, leg air will be set to “ON” automatically.
- “CALF” with “PELVIS” and “CALF” with “TWIST” cannot be set simultaneously.
- If the “PELVIS” and “TWIST” in addition are set to “ON” when the leg PELVIS air is “OFF”, PELVIS air will be set to “ON” automatically.
- “CALF” and stretch operation cannot be set simultaneously.

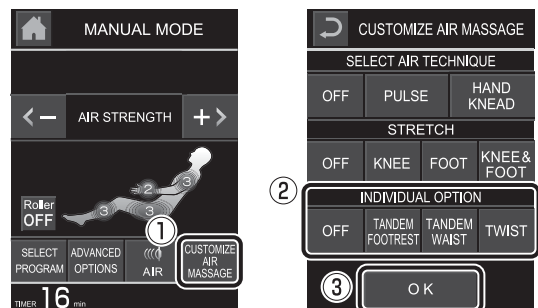

AIR MESSAGE OPTION

[PULSE]

Massage is carried out bit by bit many times by air.

[HAND KNEAD]

Air operation speed is changed and massage is done firmly.

[TANDEM FOOTREST]

Calf massage can be done simultaneously with other air massage.

[TANDEM WAIST]

Waist part massage can be done simultaneously with other massage.

[TWIST]

Twist operation massage is carried out around the waist center

[KNEE]

Leg is gripped by air and stretched in forward direction.

[FOOT]

Leg is gripped by air and stretched in downward direction.





[KNEE & FOOT]

Leg is gripped by air and stretched in downward direction while stretching in forward direction.



Parts intensive massage

Start to part intensive massage

1. Switch ON the Power by pressing

- Regular screen is displayed.
- The seat back is reclined and footrest raises automatically up to the standby position.
(When reclining angle of   or footrest angle of   or  is pressed, it is stopped)
- If the machine is not operated for more than 3 minutes, then it is switched OFF automatically.

2. Select the preferred part intensive massage by pressing .

- Moving to other part intensive menu can be done with  .

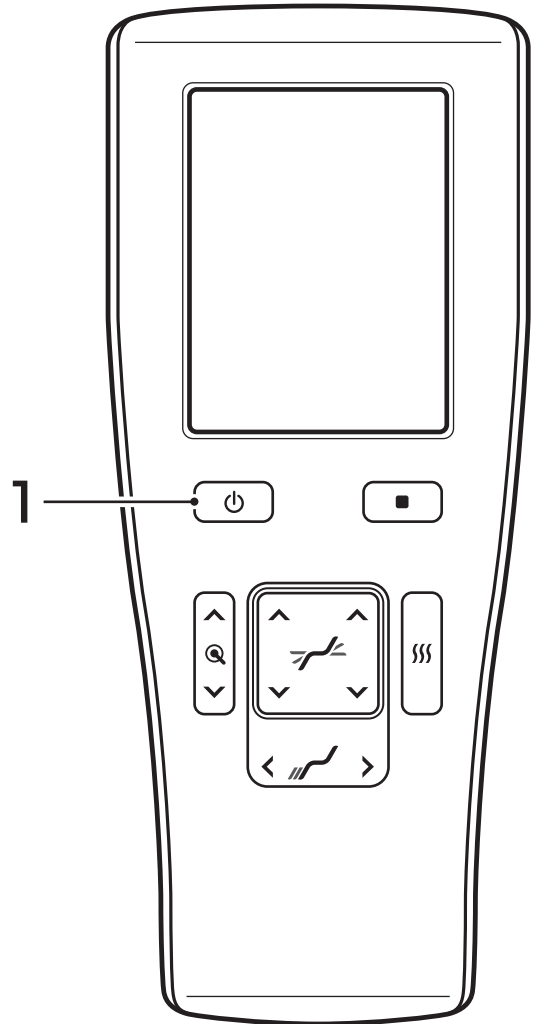
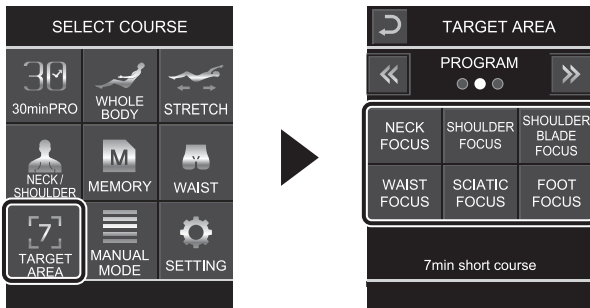

3. Shoulder position detection or waist position adjustment.

- Massage will begin after completion.
(There is no shoulder position detection and waist position adjustment during SCIATIC FOCUS)

[Example] While selecting SHOULDER BLADE FOCUS

① Press SHOULDER BLADE FOCUS

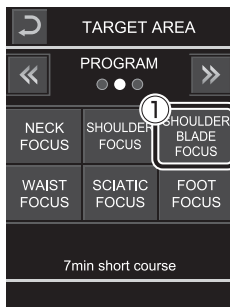

② Shoulder detection has begun.

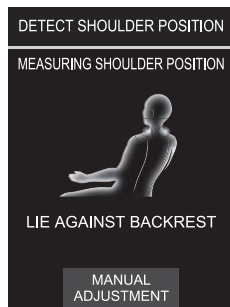

③ Massage has begun.

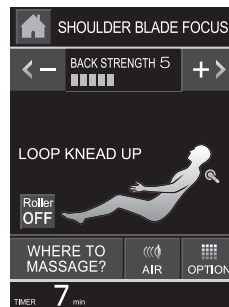

About operation of part intensive massage

It is a 7 minutes mini course for massaging the part intensively using knead technic. Combination of air massage is available for NECK FOCUS/SHOULDER FOCUS/SHOULDER BLADE FOCUS/WAIST FOCUS/SCIATIC FOCUS

The details list that can be adjusted during course of each part intensity

Parts intensity technic		Mecha strength	Air strength	Shoulder Position	Waist position	Combination of foot roller
Short Program	NECK FOCUS	●	Adjustment can be done when the air massage is combined. Refer P40, for the combined air massage	●	-	●
	SHOULDER FOCUS	●		●	-	●
	SHOULDER BLADE FOCUS	●		●	-	●
	WAIST FOCUS	●		-	●	●
	SCIATIC FOCUS	-		-	-	●
	FOOT FOCUS	-	●	-	-	● (It can not be turned off)
Stretch	NECK STRETCH	-	●	●	-	-
	BACK STRETCH	-	●	●	-	-
	WAIST STRETCH	-	●	-	●	-
Relax	UPPER CORE	●	●	●	-	-
	LOWER CORE	●	●	●	-	-
	LOWER CORE STRETCH	-	●	-	-	-

Adjustment method during massage

To adjust the strength of mecha massage

① Adjust the back strength by using **+>** for increase and by using **<-** for decrease.

- Strength can be selected from 7 steps.
- The initial setting is set in "5".

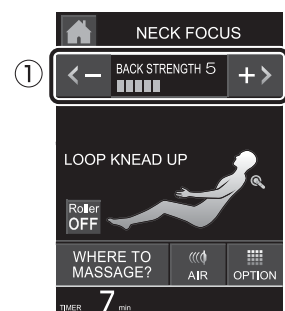

Adjustment method during air massage

[In the case whole adjustment]

① Total Air strength can be reduced with **<-** and increased with **+>**.

- The default setting will be [SHOULDER, PELVIS, FOOT 3] and [ARM 2].

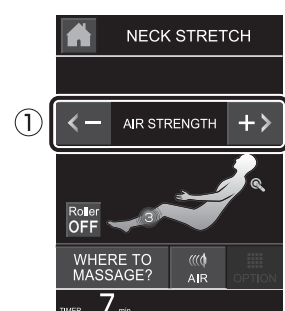

Combine the rubbing and air massage

Combine the air massage during rubbing massage operation

1. Press the "AIR".
2. Select the strength of the desired part and press **OK**.
3. Start the air massage of selected part.

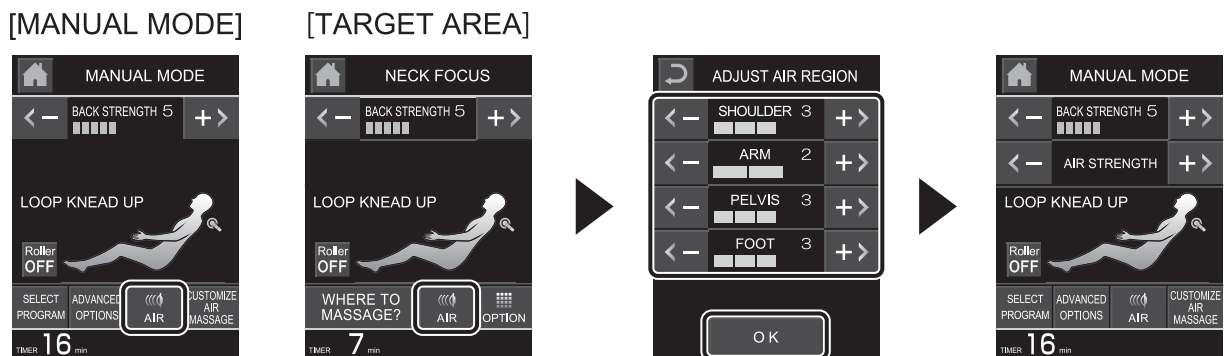

Combine the rubbing massage during air massage operation

1. Press the "SELECT PROGRAM".
2. Select the desired rubbing massage.
3. Start the selected rubbing massage.

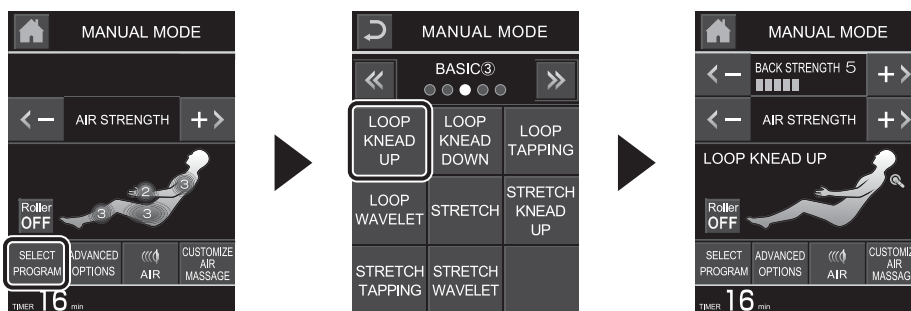

Foot roller massage

WARNING

Do not hit toes to the foot rollers. Injury may occur.

「Foot roller massage」 can be used with the combination of auto course or manual massage.
※It can not be used alone.

1. Press 「Roller」 while having auto course or manual massage.

- Each time you press the button, it switches to 「1」→「2」→「3」→「OFF」.
- When you turn the foot roller massage 「ON」, Foot air turns automatically 「ON」.
When foot roller massage is 「ON」, foot air can not be turned 「OFF」.
- Depending on the selected course or massage program, foot roller can not be combined or turned OFF. Refer to 「About auto course」(P.27), 「Mecha massage function list table」(P.34), 「About operation of part intensive massage」(P.39)

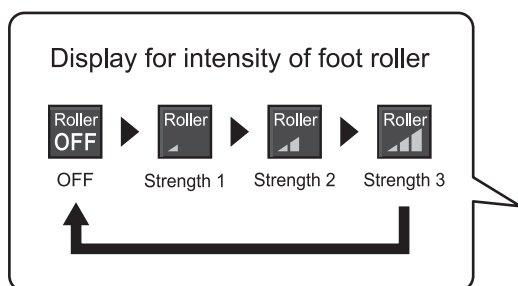

Foot roller

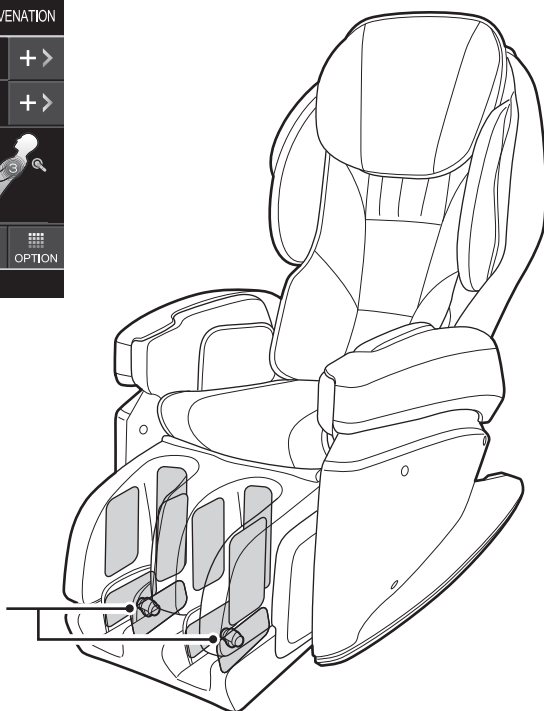

When changing the Massage in the middle

Change to auto course

1. or is pressed.
2. Select and press from these Buttons. Press the selected course button and select the desired course.

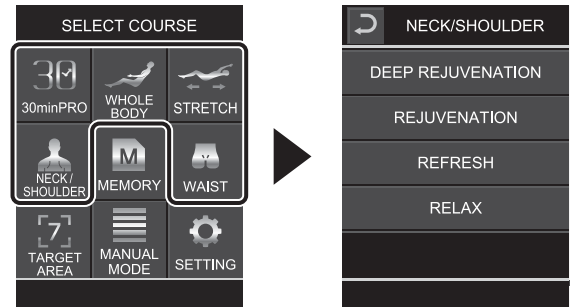

- There is a chance of muscle line or shoulder position detection. For details, check "Massage by Auto Mode Course" (P22).
- Timer for massage operation time is continued.

Change to part intensive massage

1. or is pressed.
2. Select the preferred part intensive massage by pressing .

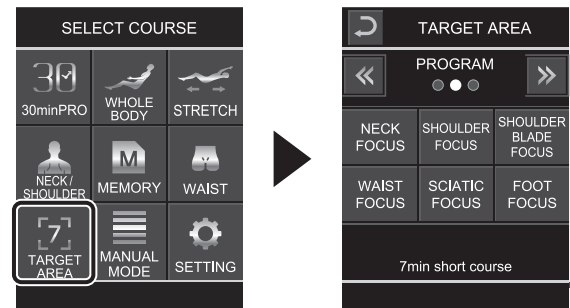

- There is a chance to carry out shoulder position detection or waist position adjustment.
- Timer for massage operation time is continued.

Timer continuation during course selection

※ It will not be operated in any combination if it exceeds 30 minutes.

- 30 minutes course (start 16 minutes or more) → Normal 16 minutes course

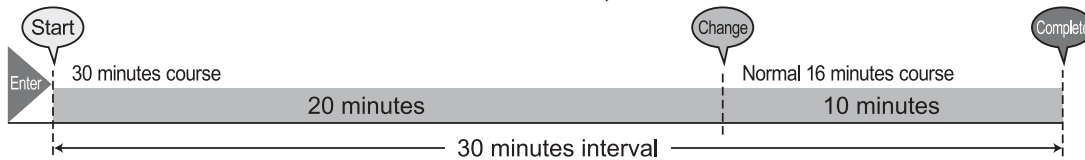

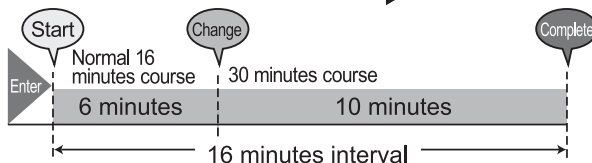

- Normal 16 minutes course → 30 minutes course (start 16 minutes or more)

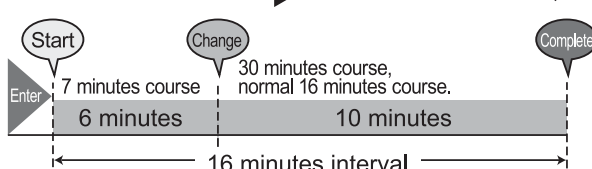

- 7 minutes course → 30 minutes course, normal 16 minutes course





Change to MANUAL MODE massage

1.  or  is pressed.
2. Press the **MANUAL MODE**, select the desired mecha massage menu and select the mecha massage.

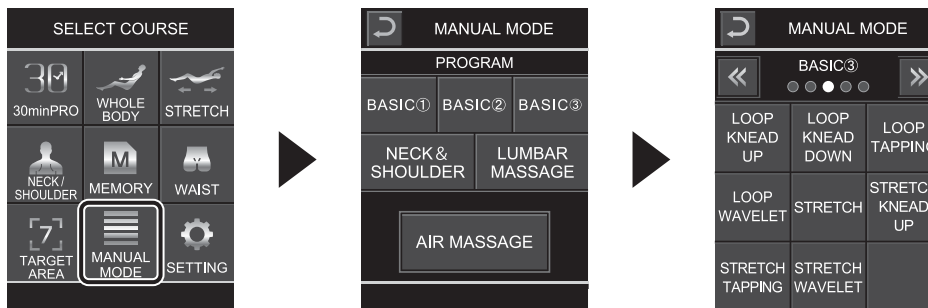
● Timer for massage operation time is continued.



Change to air massage

1.  or  is pressed.
2. Press **MANUAL MODE**, and press "AIR MESSAGE".
3. Select the preferable pressure and press **OK**.

● Timer for massage operation time is continued.

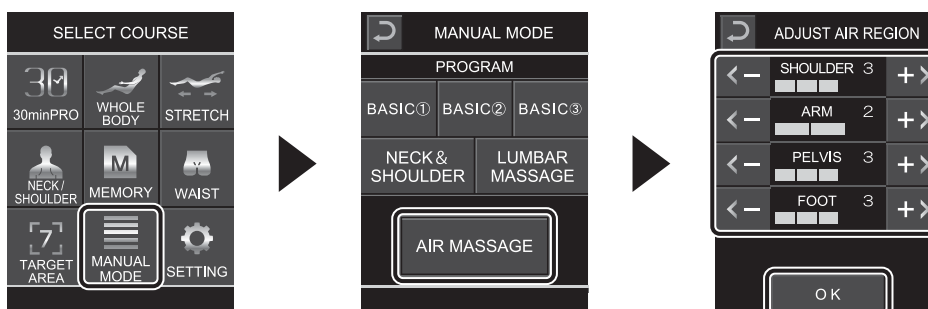

Memory course usage

The program is changed to base for the preferable automatic course and peculiar auto course can be set by registration. First "WHOLE BODY REJUVENATION course" is registered.

That can be memory registered

- Selected auto course
- Selection point of skip/ repeat
- Air option (PULSE, HAND KNEAD, with CALF, with WAIST)
- Foot roller (ON/OFF, Intensity)
- Figure information (Spinal column line, Shoulder position, Waist position)
- Air massage operation point (ON/OFF of SHOULDER, ARM, PELVIS, FOOT)
- Stretch operation
- Heater

Caution

- Massage strength (Knead ball, air) cannot be memory registered. Whenever you use this, kindly adjust.
- The status during air massage operation point, air option, shoulder position, waist position, stretch operation and heater can be memory registered.
- Skip/ repeat cannot be operated during 30min PRO course, STRECH course.
- Based on the selected course, some fields might not be adjusted.

To record the Memory

1.  is pressed and power is switched ON.

2. Press **MEMORY** and select "RECORD PROGRAM"

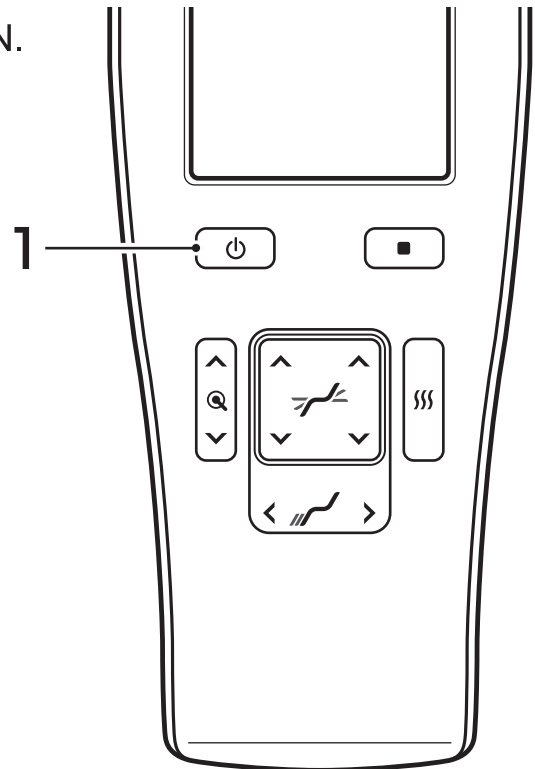
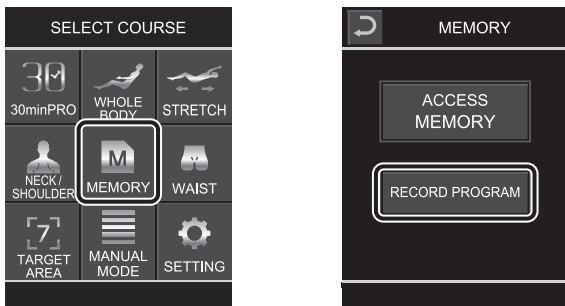

3. Preferable auto course is selected from **30minPRO** **WHOLE BODY** **STRETCH** **NECK/ SHOULDER** **WAIST** and perform a massage which will suit one self.

- During memory course registration "Memory icon(Red)" is displayed.

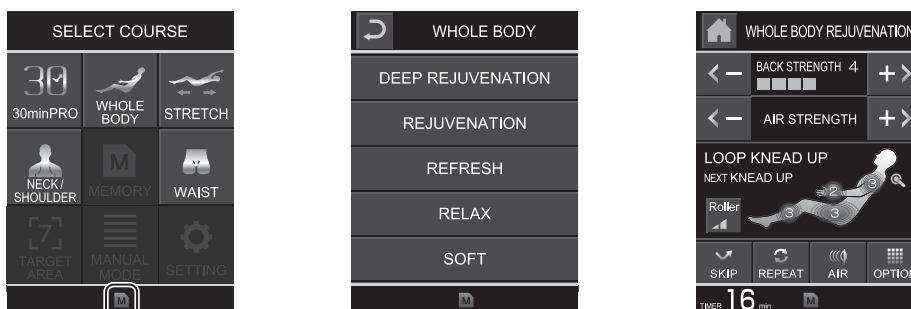

Memory icon(Red)

4. After the end of course, registration will begin if “YES” is pressed in memory course registration verification screen. Registration is completed when “REGISTRATION COMPLETED” is displayed.

- After registration completion, power supply will be disconnected.
- When the registration is in progress, do not cut the power supply. Automatic course details will not be registered.

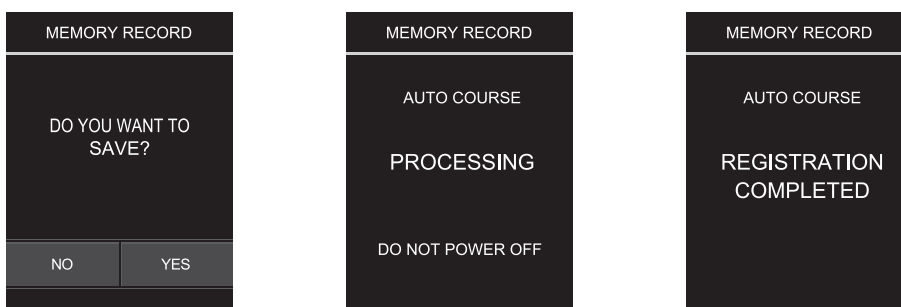

Usage Example

① Select the “Refresh Course” of “whole body”.



② Skip “3D taping” that is after 6 min of massage start and repeat the “SHIATSU” that is after 9 min of start.



③ Adjust the options.

- PULSE “ON” → HAND KNEAD “ON”



- AIR SETTING → “SHOULDER OFF”



5. After registration completion turn on the power by pressing this .

Then press **MEMORY**.

On pressing “MEMORY START” massage will begin with the registered details.

- If the memory is registered, "Memory icon(white)" will be displayed when memory course is not executed.
- When the registered memory course is executed, "memory icon(green)" will be displayed.
- For changing overwrite the registered memory details, perform "Memory is registered (P44)" from the beginning.
- To delete the registered memory, Refer to remove the "DELETE MEMORY" (P46).

To delete the registered memory

1.  is pressed and power is switched ON.

2. Press **MEMORY**,
then "CLEAR SAVED PROGRAMS".

- If the memory course is not registered "CLEAR SAVED PROGRAMS" will not be displayed.

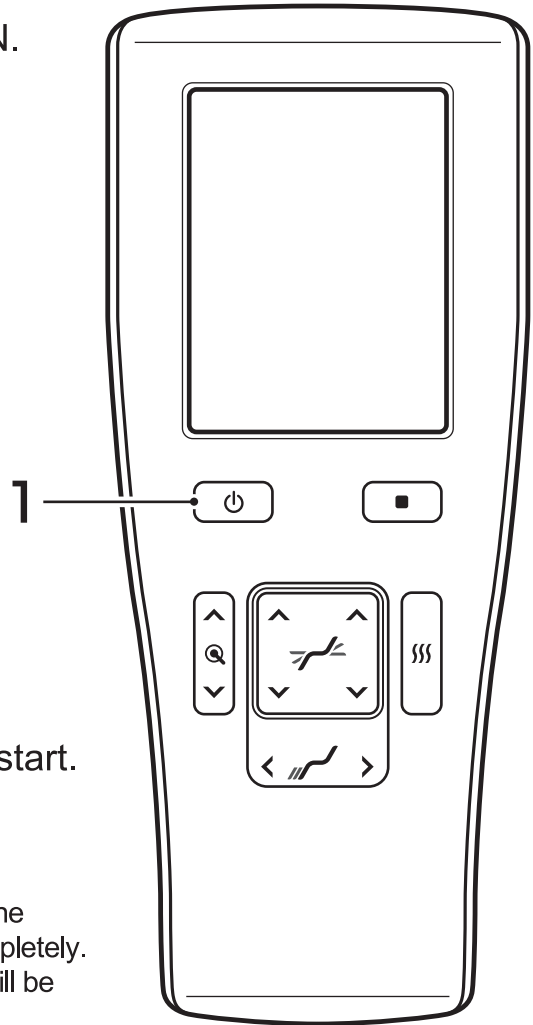
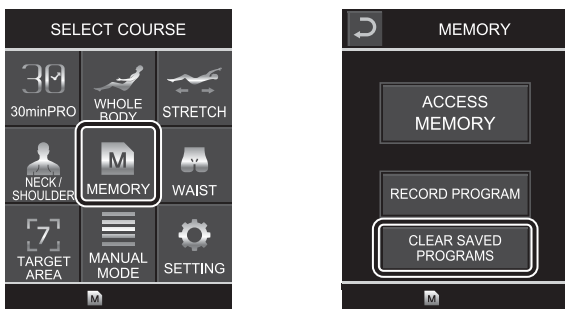

3. If "Yes" selected in confirmation screen of "CLEAR SAVED PROGRAMS", removal will start. On completion of removal "DELETE COMPLETED" will be displayed.

- When memory course removing is in progress, do not cut the power supply. Doing so, removal will not be performed completely. If the memory course is removed, registration of memory will be returned to "whole body REJUVENATION". If the memory course is removed, display of "memory icon (white)" will disappear.

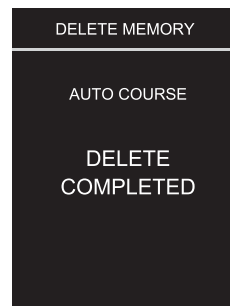
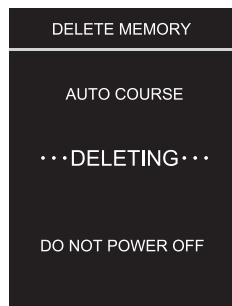

Heater ON/OFF

DANGER

Do not use the heater for long time, and do not use the heater in same place for long time.
It may cause low temperature or injury
Even at comparatively low temperature (40~60C), and do not use the heater in same place of the skin for long time.
It may cause low temperature or injury

1. Press the heater icon .

- In case the massage and heater are used simultaneously, if the massage is ended, then heater is also ended.



Heater icon

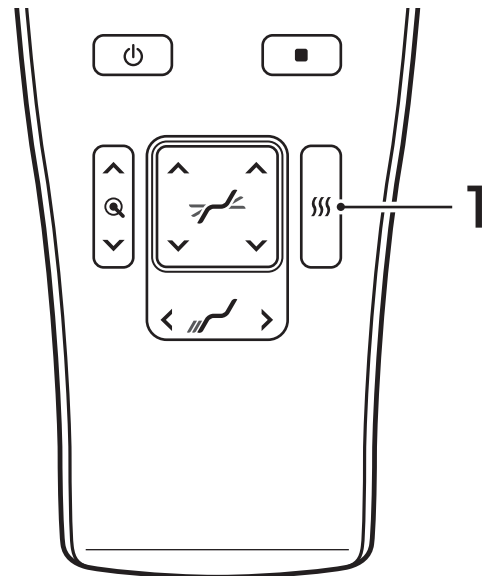

- Heater can be used by itself, by pressing  .
- When the heater is used by itself, it will be automatically cut off after about 60 minutes.

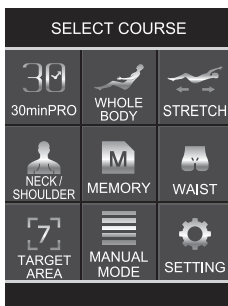

Back heater
(Equipped in
the backrest)

Foot heater
(Equipped in
the part of toes)

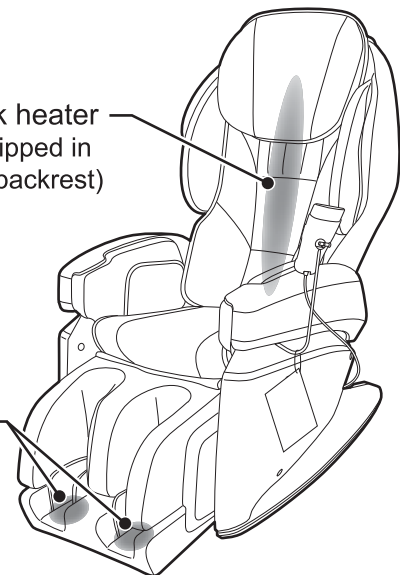

QUICK MODE / LANGUAGE / AUTO-RECLINE settings

About QUICK MODE settings

“QUICK MODE” is the operation mode in which the bold characters are displayed to enhance the visibility and it is with simplified operation

1. Press **SETTING** in the regular screen.
2. If you press QUICK MODE to “ON” and then press **OK**, then QUICK MODE screen will be displayed.
3. If you select the preferred course, then auto course is started.
 - If you press “MODE CANCEL”, then it will move to former regular screen.
 - Even if the power switch off the main unit, QUICK MODE will be continued.

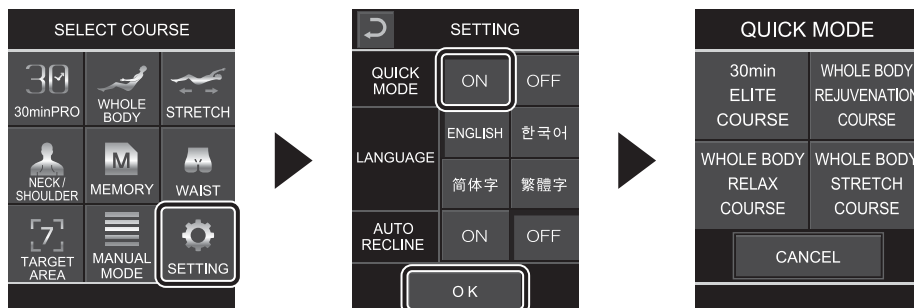

About LANGUAGE

[Switch to other language]

1. Press **SETTING** in the regular screen ,
each language (한국어, 简体字, 繁體字) is selectable.
 - Each operation method is similar to English



About AUTO-RECLINE setting

“Auto Reclining” is the function that raises the back rest automatically during power off and massage end and the one that accommodates the foot rest and switches off the power.

1. Press **SETTING** in the regular screen.

2. Press “ON” in the auto reclining and press **OK** in the regular.

- When press 「AUTO UPRIGHT(POWER OFF)」 while backrest and footrest are stored, auto upright stops. Press again to restart auto upright.
- When storing, footrest is stored first and backrest is moved up.
- Depending on the angle of backrest when the massage is done, storing of backrest sometimes stops on the way. Press 「AUTO UPRIGHT(POWER OFF)」 again for complete upright. Refer to below chart of 「About AUTO UPRIGHT button」 for more detail.
- 「ON/OFF」setting of auto reclining remains even if main power is turned on again.

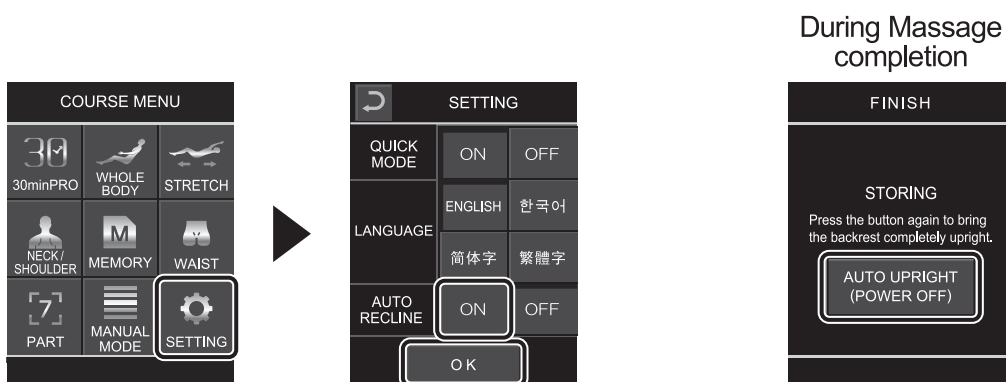

About AUTO UPRIGHT button (In case the auto reclining setting is OFF)

In case the backrest is reclined lower than standby position when the massage is done, press the button twice for complete storage.



In case the backrest reclined higher than standby position, press the button once for complete storage.

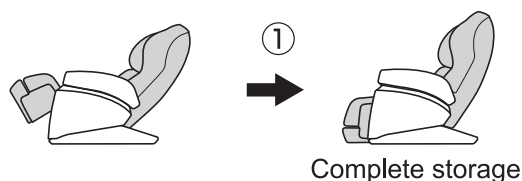

※When you want to turn the auto reclining setting ON, ① is automatically done.

※Refer to P.18 for standby position.

To set the child lock

[Child lock] function disables the button press so that the child cannot operate it by mistake.

1. Press  of reclining and accommodate the backrest and foot rest.

- When child lock is in progress, all the operations are not possible. Accommodate the back rest and foot rest in advance.

2. In the regular screen, if you long press  for 3 seconds approximately, a “Beep” will ring and the child lock screen will be displayed.

- After setting the child lock, if you do not operate within 30 seconds, then the screen will disappear. If you press , then the child lock screen will be displayed.
- When releasing the child lock, either perform the same operation or switch the power of main unit to “OFF”.

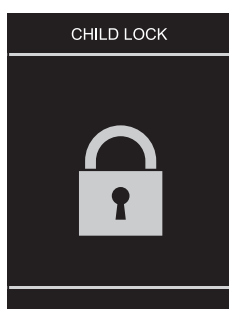
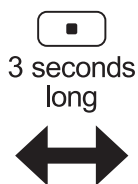
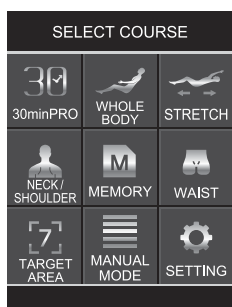
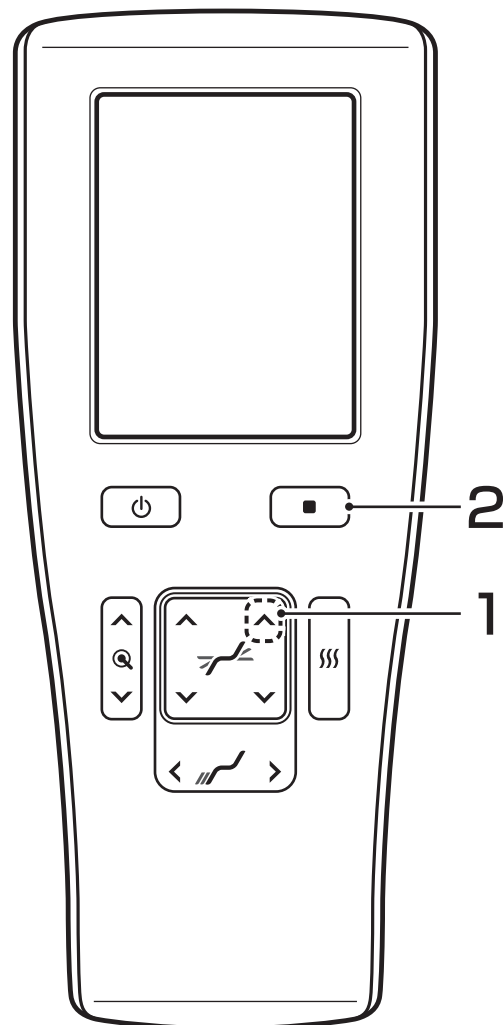

MEMO

Maintenance and storage

How to maintain the chair

DANGER

Do not connect or disconnect the power plug by wet hands. Electrification may occur.

WARNING

Make sure to unplug the power plug. Electrification may occur. Do not wipe with benzine, paint thinner or alcohol. This may cause fire or electrification.

Cloth/Back pad/Pillow

1. Instill water containing neutral detergent and squeeze firmly.
2. Wipe the dirty part with the cloth.
3. Wipe it out with a tight squeezed cloth which is water contained.
4. Dry it naturally after wiping out with a dry cloth.
 - Do not iron. It may damage the fabric.
 - Attention to use the machine with wearing colored clothes as color may adheres to fabrics or cloth.
 - After using the machine with hairdressing on, put something like towel on where your head touches as it may cause the change of color or cracking.

Resin part

1. Instill water containing neutral detergent and squeeze firmly.
2. Wipe the dirty part with the cloth.
3. Wipe it out with a dry cloth not to leave detergent.
 - Do not use scouring powder. It cause scratches, discoloration, cracks.

Remote control, lower back(Control box)

Wipe out with a dry cloth.

- Do not wipe out with a wet towel. It may cause malfunction.

How to storage

DANGER

Do not use or store in the bathrooms or places of high humidity or moisture. Electrification, fire, accidents, and moulding may occur.

Store the chair in the places which is less adverse effect by temperature, humidity, dusts after wiping out the dirt and dusts on the chair. When the chair won't be used for a long time, put a cover on the chair and avoid the chair from dust.

- Do not store the chair near a stove or the places which chair is exposed direct sunlight for a long time. It may cause discoloration, deterioration.

How to move the main unit

WARNING

Do not move the chair while people or items are on the chair. Damage or injuries may occur.
Do not haul the chair itself or move with the casters on the floor where it easily gets scratches.
Do not pull the power chord or remote control chord with leg or wrap with caster.
Failure to do so may cause injury.

When moving with Caster

Float the front side of the main unit, push it and move.

- While lowering the main unit, lower slowly so that the leg part does not get hit.

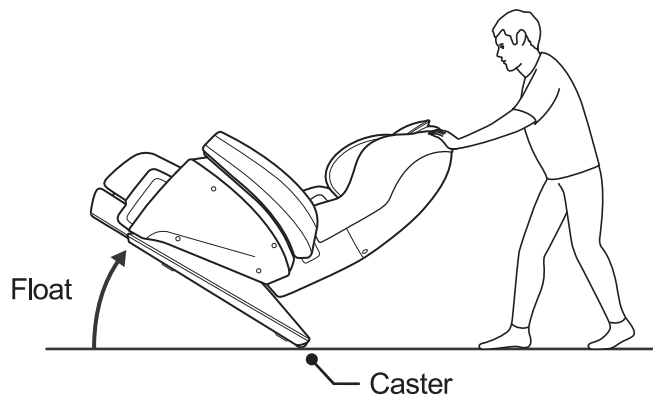

When more than 2 persons are lifting

Dismantle the arm unit and the arm rest, and after lowering the back rest part, hold the lower part of the front side and back rest with hands (Refer the below diagram) and then lift and move.

- Refer to P12~15 for the method to dismantle the arm unit and arm rest.
- As it is very heavy, select more than 2 persons surely.
- Please watch your steps carefully and lower it slowly.

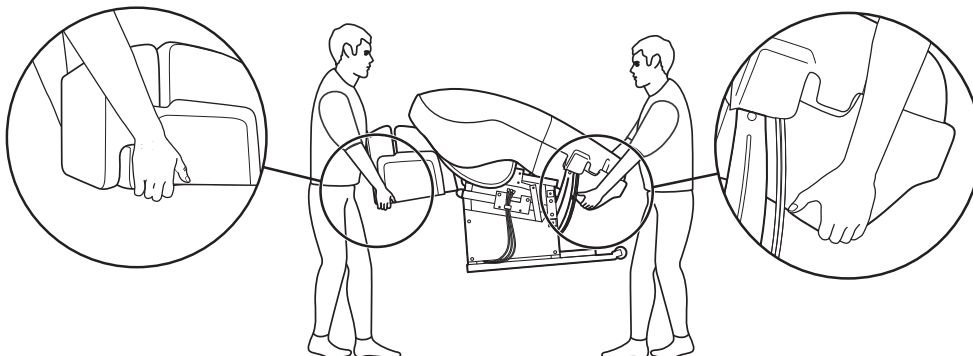

Q&A

Q1 Left and right strength is different. And, I feel the difference is remarkable.

A To massage for a better feeling, in connection with adopting a mechanism in which the rubbing will mutually hit, unavoidably, the operation might take place in the knead ball slipped position. Thereby, you feel that there is a difference among the left and right strength. But it is not a failure.

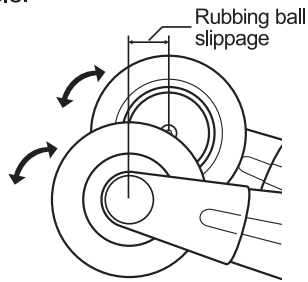

Q2 Is there even more strong massage?

A To massage for a better feeling, in connection with adopting a mechanism in which the rubbing will mutually hit, unavoidably, the operation might take place in the knead ball slipped position. Thereby, you feel that there is a difference among the left and right strength. But it is not a failure.

Q3 The remote control holder is loosened...

A Retighten the fixing screw. When a part of remote control holder is sliding, inlay by loosening the fixing screw and tighten it once again. Also, check the fitting screw of the sand and if it is loosened, retighten with the hexagon wrench of the accessory.

Q4 Leg is not fitting properly in the leg part...

A Adjust by expanding and narrowing the leg part.

- For short people: Raise the back rest part and elevate the leg part.

Q5 I am commuting to hospital, is it ok to use?

A Consult with the doctor in the hospital and then use. "Touch pressure stimulation" refers to the action that promotes the blood circulation for massage by relieving the stress in the muscles. According to the illness, there are risks of getting worse. Hence you should consult with the doctor.

Q6 What is the electricity utility expense for a month?

A If you use heater and massage every day for approximately 30 minutes per day, then it is roughly 53 Yen per month. If you use only massage every day for approximately 30 minutes per day, then it is roughly 3 Yen per month. If you use heater for 1 hour every day, then it is roughly 32 Yen per month. Electricity charges standard unit price: Calculated to be 27 Yen/kWh (Including the taxes).
(Currently, 2015/9, Our company survey in Japan)

Q7 Is it ok to spread the hot carpet under the chair?

A As there is a danger of flame, please stop. Heat generation of hot carpet pains the body and thereby it might generate flame.

Q8 Can the leg be lowered up to the storing position?

A When using foot air or foot roller massage, footrest does not lower to standby position. Turn 「OFF」 foot air or foot roller. (Refer to P.35, P.41)

Q9 Won't the backrest or the leg move to standby position automatically?

A When the backrest part is lowered below or the leg is raised above the standby position, it will not go back to standby position even if you press  button.

Q10 Can this be used by people of height below 150 cm or above 185 cm?

A Yes, you can use. During sensing, the shoulder position might not match even if you adjust the shoulder position and so proceed using the following methods.

- Short person: Raise the backrest and leg part.
- Tall person: Lower the backrest and leg part.

Q11 Arm is not reaching the arm unit. What to do?

A Raise the backrest and adjust the arm position

Q12 Will the shoulder and arm become red after shoulder/arm air massage?

A After usage, there might be traces of the massage. That's due to the massage. It will disappear in due course of time. And, while doing shoulder air massage, avoid clothes that will expose the shoulders.

Q13 Even if sensing is done, shoulder position is not matching.

A Sit comfortably, lean the face so that it rests in the backrest and after that do the sensing. This can be adjusted manually.

Q14 Is it possible to use by removing the arm?

A No, it is not possible. Air supply and exhaust vent will be exposed, trash and dust will be accumulated and this will be the cause for failure.

Q15 During massage, some creaky noises are made. Is it ok?

A There is nothing abnormal in the structure. Refer to "Trouble shooting".

Q16 If you do a foot stretch, sometimes there is a squeaky noise.

A Noise might be generated, but it is not a failure. In the structure, when the electric actuator is isolated from the leg, noise might be generated.

Q17 Is it possible to completely cut off the air massage in the auto course?

A It is possible in the course other than 30min PRO course and stretch course. Please refer to "Adjustment method during air massage". And during "WHOLE BODY AIR" in stretch course, if you set the entire air massage to "OFF", then it will be massage end (While stowing) screen and the power will be cut.

Q18 It is difficult to feel the differences when change the intensity of foot roller.

A It sometimes is difficult to feel the differences of intensity as the intensity of foot roller is adjusted by the strength of pressing by the air of flaps of foot part.

Q19 Explain the dimensions of the main unit.

A Please refer to the following diagram.

Front view

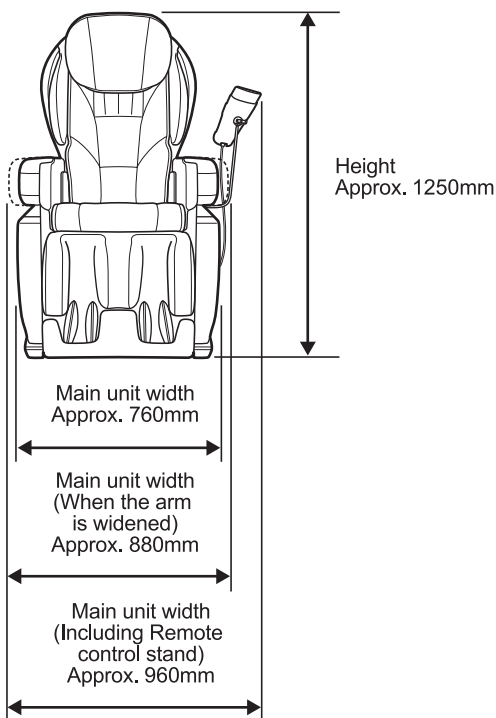

Side view

When it is not reclined

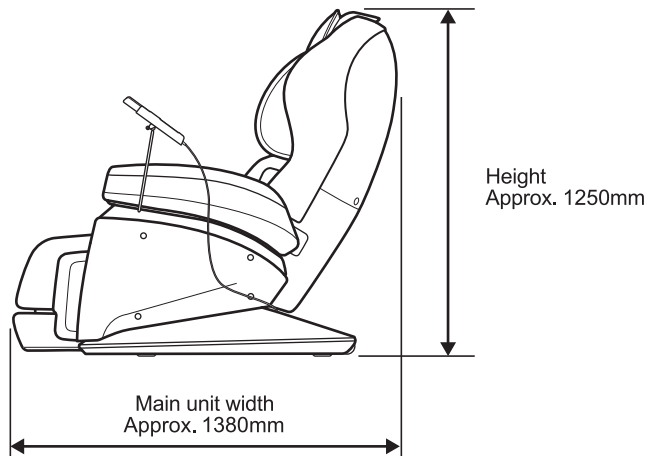

When it is reclined (When the leg part is stretched)

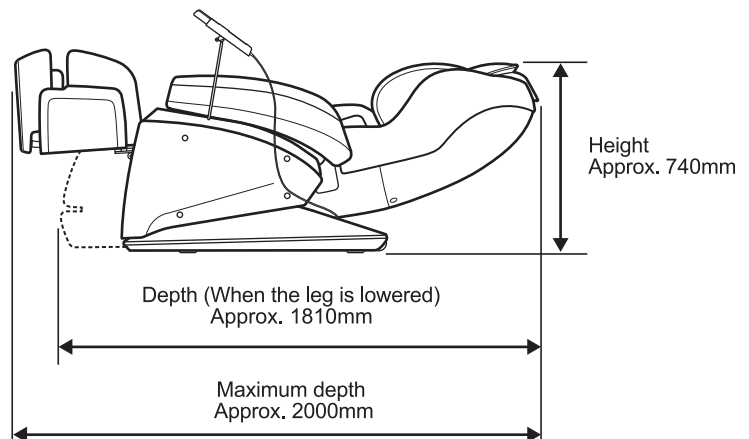

Trouble shooting

! DANGER

Do not remodel and also do not analysis or repair by yourself, there are chances of injury due to fire (or) abnormal operation

You may encounter the following phenomena while in massage. As being due to the mechanical design, they have nothing to do with the product life

- A "clatter" noise occurs when the knead balls go up and down
- A "creak" noise of the gear and the motor occurs while in massage
- A friction noise occurs when the knead balls rub the cover cloth (Particularly while in the process of knead)
- A rattling noise occurs while in the "TAPPING" or "WAVELET" massage.
(Particularly when the massage moves from the shoulders to the back)
- In the "KNEAD","TAPPING" or "WAVELET" massage, massaging speed may vary with the knead balls strength changed
- A noise becomes different when the massaging speed is changed
- A roaring noise of the motor occurs when load is given to the chair
- A "cuckoo" noise occurs while, in the Auto mode course, the knead balls are automatically adjusted to the back-and-forth position to have the chair fitting in with the user's body shape
- The compressor's noise and the air exhausting noise occur while in air-massage
- A noise occurs when the air bag is inflated
- A screaming noise occurs while in massage of the shoulder
- A grinding noise occurs when the backrest or seat are reclined (Squeak sound)
(The height of the knead balls between the left and right are different.
A mechanism is used to allow the two knead balls tapping alternatively. It occurs unavoidably and this is not the trouble)

Symptoms	Check points	Trouble shooting
The chair does not start-up	Is the power cord plug connected?	Connect the power cord plug with the receptacle
	Is the power switch of the lower part behind the main body turned off	Turn the power switch "ON"
The chair stops halfway. (The remote controller does not work)	Is the backrest in touch with the main body or the like?	Move the chair away from the main body or the like. Turn the power switch of the lower part behind the main body OFF and ON.
	Is there any load given to the knead balls?(Should there be any load given to the knead balls, a safety mechanism works to stop all the functions)	Detach the body from the backrest for a moment, turn OFF and ON the power switch of the lower part behind the main body and once again operate from the beginning.
The backrest cannot be reclined	Is the power cord plug connected?	Connect the power cord plug with the receptacle
	Is the backrest in touch with the wall or the like?	Move the chair away from the main body or the like
The leg part is not lowered to the retracting position?	Is the foot air or foot roller turned 「ON」 ?	Turn 「OFF」 the foot air or foot roller.

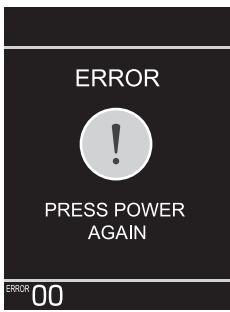

The following message may be displayed on LCD: "ERROR: Switch on Power then on/off". In this case, following the instruction, turn the power switch OFF and ON.

- When the operation could not be done normally even if the above counter measure is performed, or the same error occurs repeatedly, switch "OFF" the power switch of main body and disconnect the power cord plug from power receptacle. And then, contact your retailer or our customer care.

Checkpoints

WARNING

When using the chair after a while, read the user manual once again, check to make sure that it operates normally to use again. Failing which may cause injury or accident.



Inspection Important!

Be sure to make inspection for longer use,

Are there these symptoms?

- Chair emits scorching smell
- The power cord or the plug is overheated
- Electricity runs on or off with the power cord moved
- There are some other abnormalities

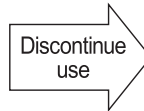

For prevention of accident or trouble, turn "OFF" the power switch of main body, disconnect the power cord plug from power receptacle, and contact your retailer or our customer care.

Specifications

Product name		massage chair	
Model number		JP-1100	
Rating	Power supply (50-60Hz)	AC100-240V	
	Rated time	30 min	
	Power consumption(50-60Hz)	130W (Standby power : 0.3W)	
	Motor power consumption	90W	
	Electric heater power consumption	40W	
Mecha(Knead balls) massage speed adjustment range	Knead	4-step adjustment (approx. 8-30 cycles/min)	
	Tapping	4-step adjustment (approx. 250-650 cycles/min)	
	Up and down	Approx. 5.4cm/second	
Air pressure for air-massage		Approx. 45kPa	
Mecha(knead balls) massage strength adjustment range	Auto course	7-step adjustment	
	Manual selection	12-step adjustment	
Adjustment range of intensity of foot roller		3-step adjustment	
Rotation speed of foot roller		Approx. 14-21 cycles/minute	
Air massage strength adjustment range		Shoulder : 5-step adjustment Arm : 3-step adjustment Waist/Buttocks : 5-step adjustment Leg : 5-step adjustment	
Auto-timer		Approx. 7, 16, 30 min	
Reclining angle	Seat back	Approx. 110°- 157°	
	Footrest	When air massage is on	Approx. 60°- 84°
		When air massage is off	Approx. 0°- 84°
Dimensions	Upright position	Approx. W760 x D1380 x H1250(mm)	
	Reclining position	Approx. W880 x D2000 x H740(mm)	
Weight		Approx. 78kg	
Upholstery		PVC leather, Polyester	
Country of Origin	Made in Japan		

MEMO

FUJIIRYŌKI

FUJIIRYOKI INDIA,186 -22 Godown Industrial Area, Jaipur, Rajasthan, India -302006